

MODEL NO.	<b>WP-300</b>	SERIES	<b>WP-300 SERIES</b>	TYPE	<b>3-GANG WALL PANEL</b>	 PROUDLY MADE IN THE U.S.A.	 <b>ACE BACKSTAGE CO</b> Stage Pocket Systems <i>Connectivity</i> www.acebackstage.com
-----------	---------------	--------	----------------------	------	--------------------------	---	--

WP-300 SERIES PANELS

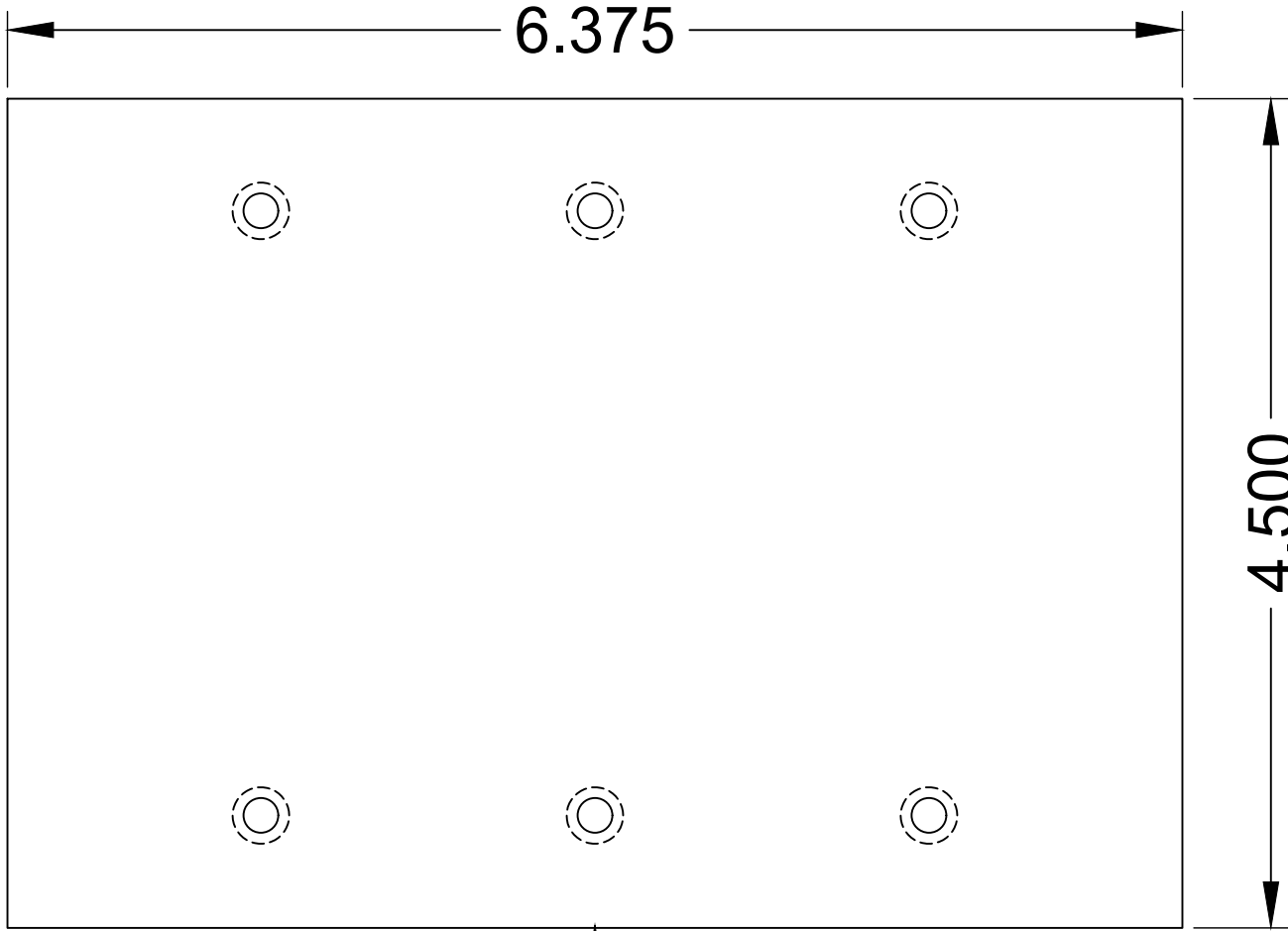
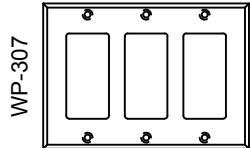
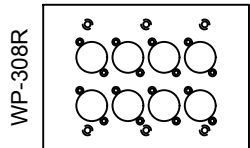
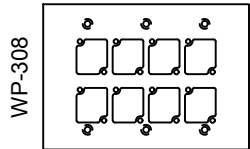
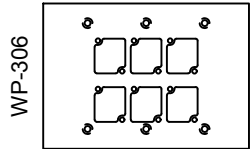
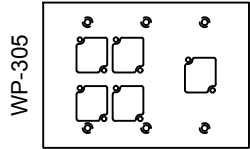
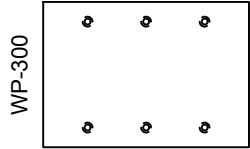

REVISED: 01/2021	MATERIAL:	FINISH:	DESCRIPTION:	REV 1
ALL DIMENSIONS ARE FOR REFERENCE ONLY. ALL DIMENSIONS ARE IN INCHES	1/16" 6061-T6 ALUMINUM	BLACK POWDER COAT, SEMI GLOSS	THREE-GANG WALL PANEL, BLANK.	SHEET 1 OF 1

**WP-300 SERIES PANELS**

WP-300

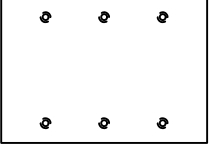

WP-305

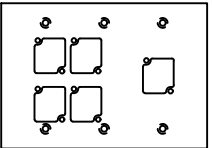

WP-306

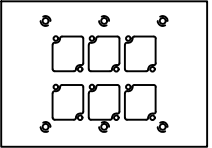

WP-308

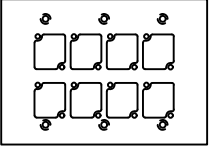

WP-308R

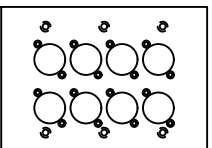

WP-307

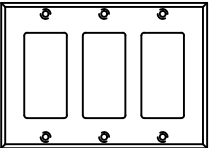

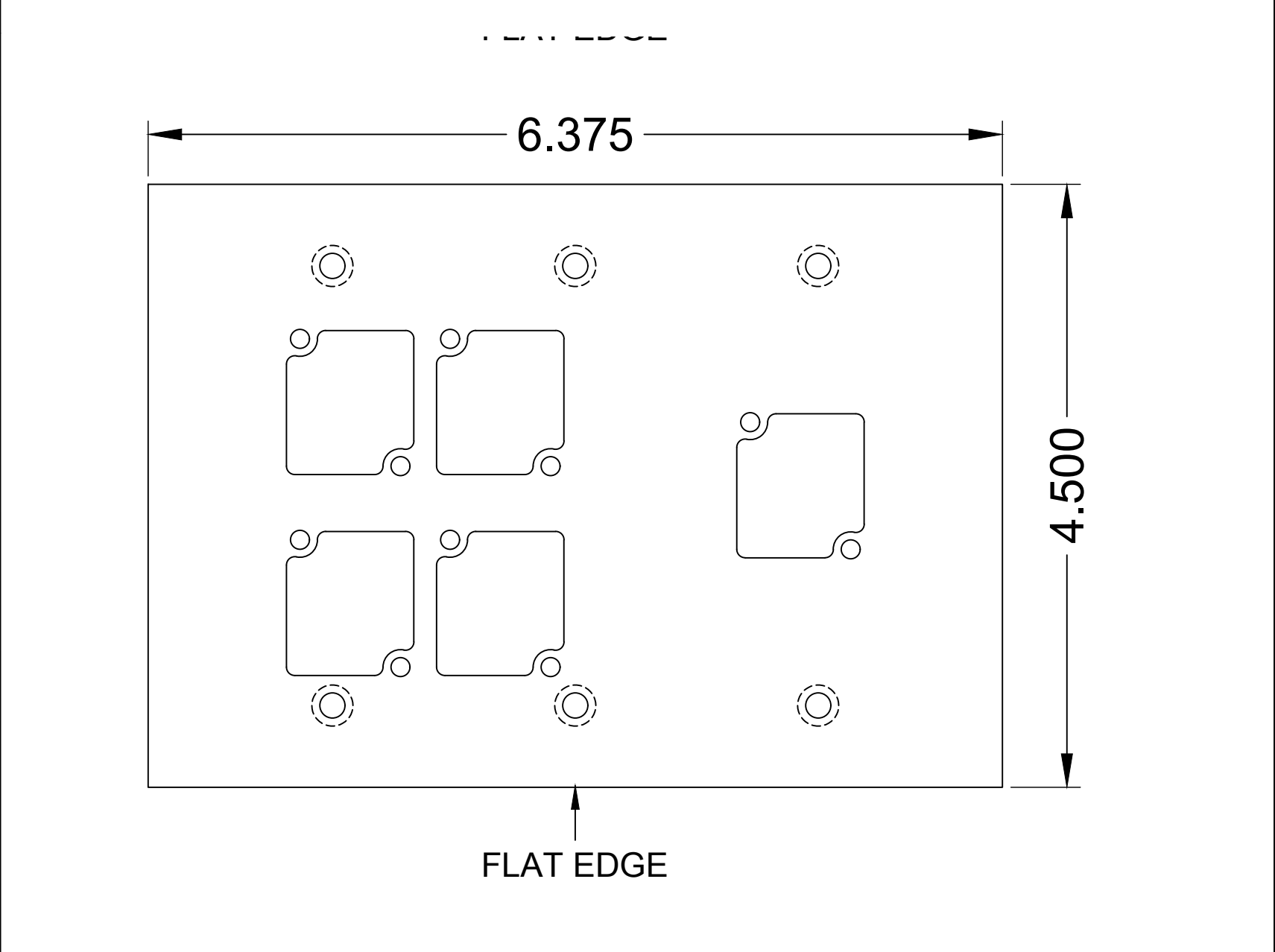

<b>REVISED:</b> 01/2021	<b>MATERIAL:</b>	<b>FINISH:</b>	<b>DESCRIPTION:</b>	<b>REV</b>
ALL DIMENSIONS ARE FOR REFERENCE ONLY. ALL DIMENSIONS ARE IN INCHES	1/16" 6061-T6 ALUMINUM	BLACK POWDER COAT, SEMI GLOSS	THREE-GANG WALL PANEL WITH (5) CONNECTRIX CUTOUTS.	1
				<b>SHEET</b>
				1 of 1

MODEL NO.	<b>WP-306</b>	SERIES	<b>WP-300 SERIES</b>	TYPE	<b>3-GANG WALL PANEL</b>	 PROUDLY MADE IN THE U.S.A.	 <b>ACE BACKSTAGE CO</b> Stage Pocket Systems <i>Connectivity</i> www.acebackstage.com
-----------	---------------	--------	----------------------	------	--------------------------	---	--

WP-300 SERIES PANELS

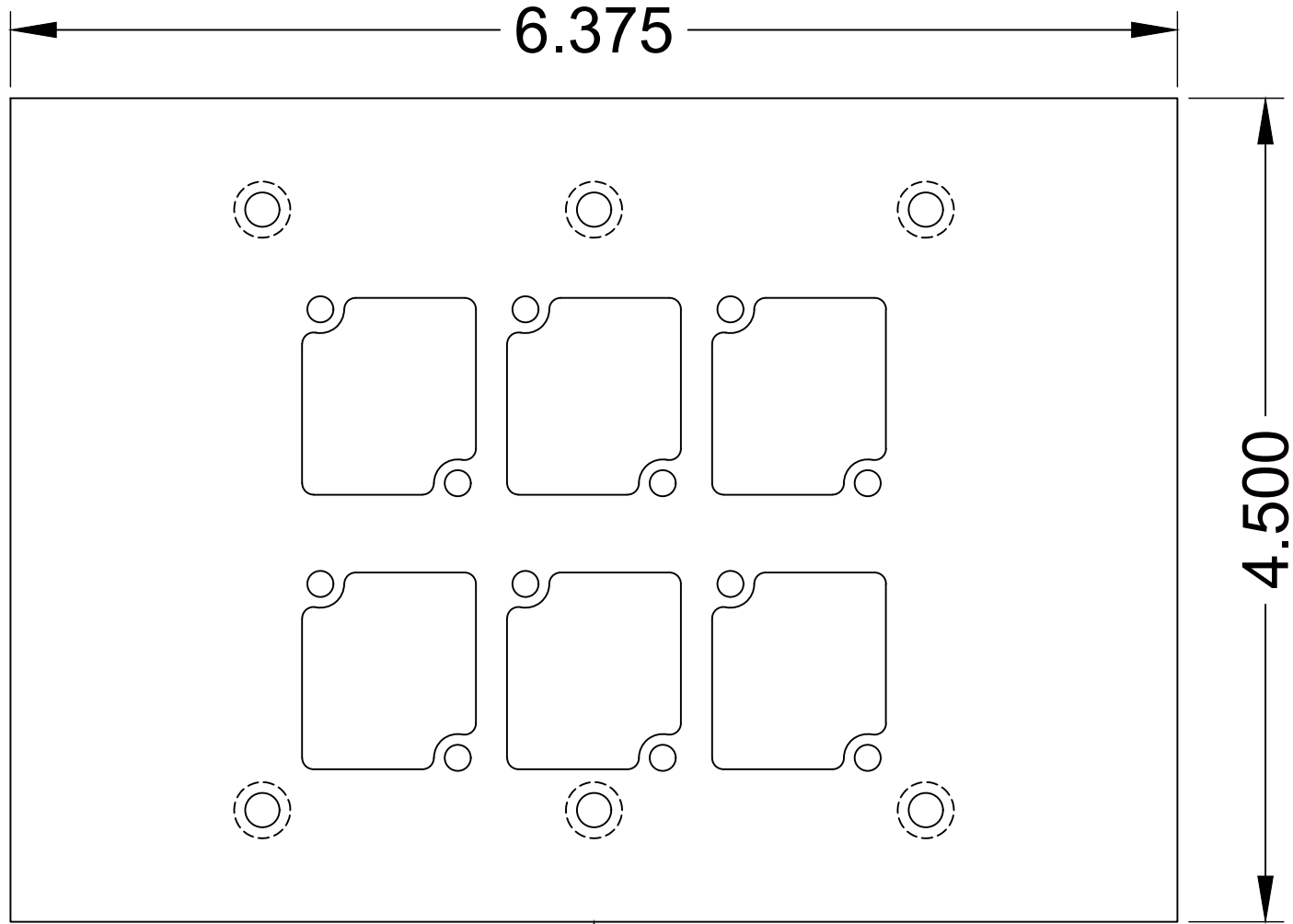
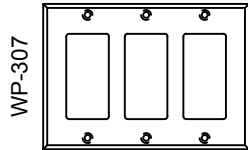
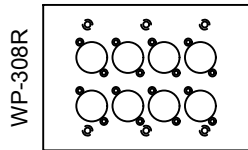
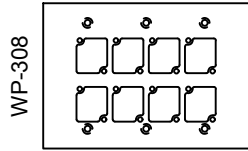
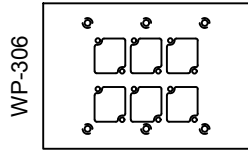
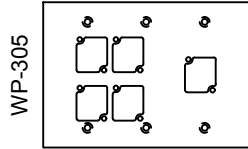
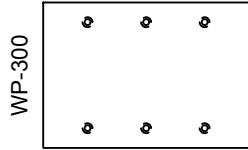

REVISED: 01/2021	MATERIAL:	FINISH:	DESCRIPTION:	REV 1
ALL DIMENSIONS ARE FOR REFERENCE ONLY. ALL DIMENSIONS ARE IN INCHES	1/16" 6061-T6 ALUMINUM	BLACK POWDER COAT, SEMI GLOSS	THREE-GANG WALL PANEL WITH (6) CONNECTRIX CUTOUTS.	SHEET 1 OF 1

MODEL NO.	<b>WP-307</b>	SERIES	<b>WP-300 SERIES</b>	TYPE	<b>3-GANG WALL PANEL</b>	 PROUDLY MADE IN THE U.S.A.	 Stage Pocket Systems <b>Connectivity</b> www.acebackstage.com
-----------	---------------	--------	----------------------	------	--------------------------	---	--

WP-300 SERIES PANELS

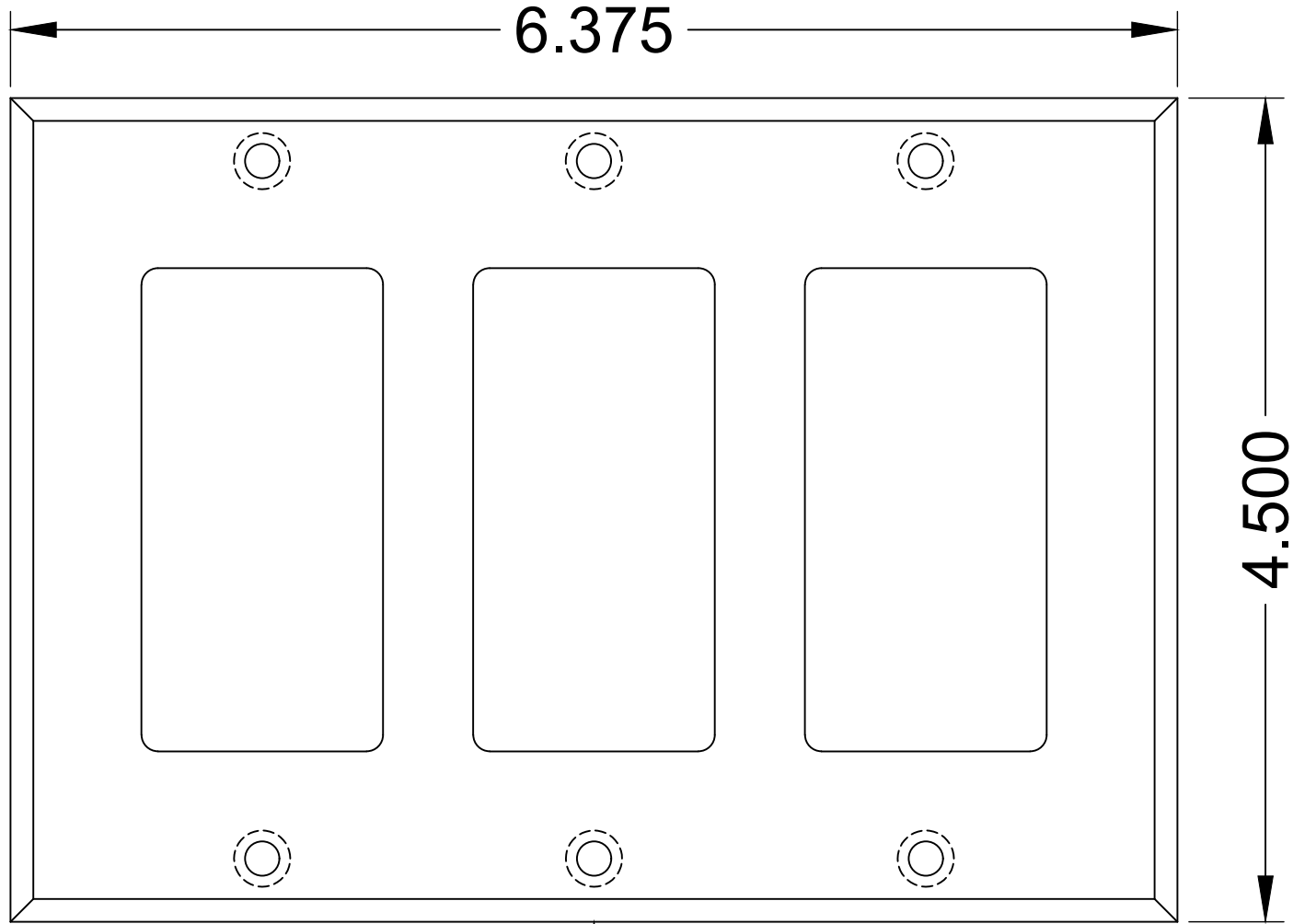
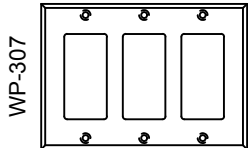
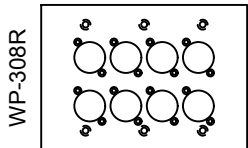
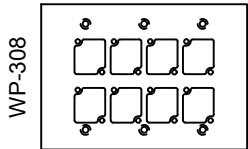
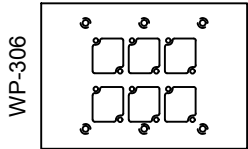
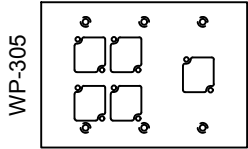
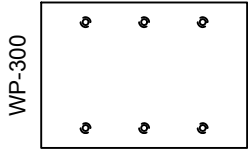

BEVELED EDGE

REVISED: 01/2021	MATERIAL:	FINISH:	DESCRIPTION:	REV 1
ALL DIMENSIONS ARE FOR REFERENCE ONLY. ALL DIMENSIONS ARE IN INCHES	1/16" 6061-T6 ALUMINUM	BLACK POWDER COAT, SEMI GLOSS	THREE-GANG PANEL WITH (3) DECORA CUTOUTS.	SHEET 1 OF 1

MODEL NO.	<b>WP-308</b>	SERIES	<b>WP-300 SERIES</b>	TYPE	<b>3-GANG WALL PANEL</b>	 PROUDLY MADE IN THE U.S.A.	 <b>ACE BACKSTAGE CO</b> Stage Pocket Systems <i>Connectivity</i> www.acebackstage.com
-----------	---------------	--------	----------------------	------	--------------------------	---	--

WP-300 SERIES PANELS

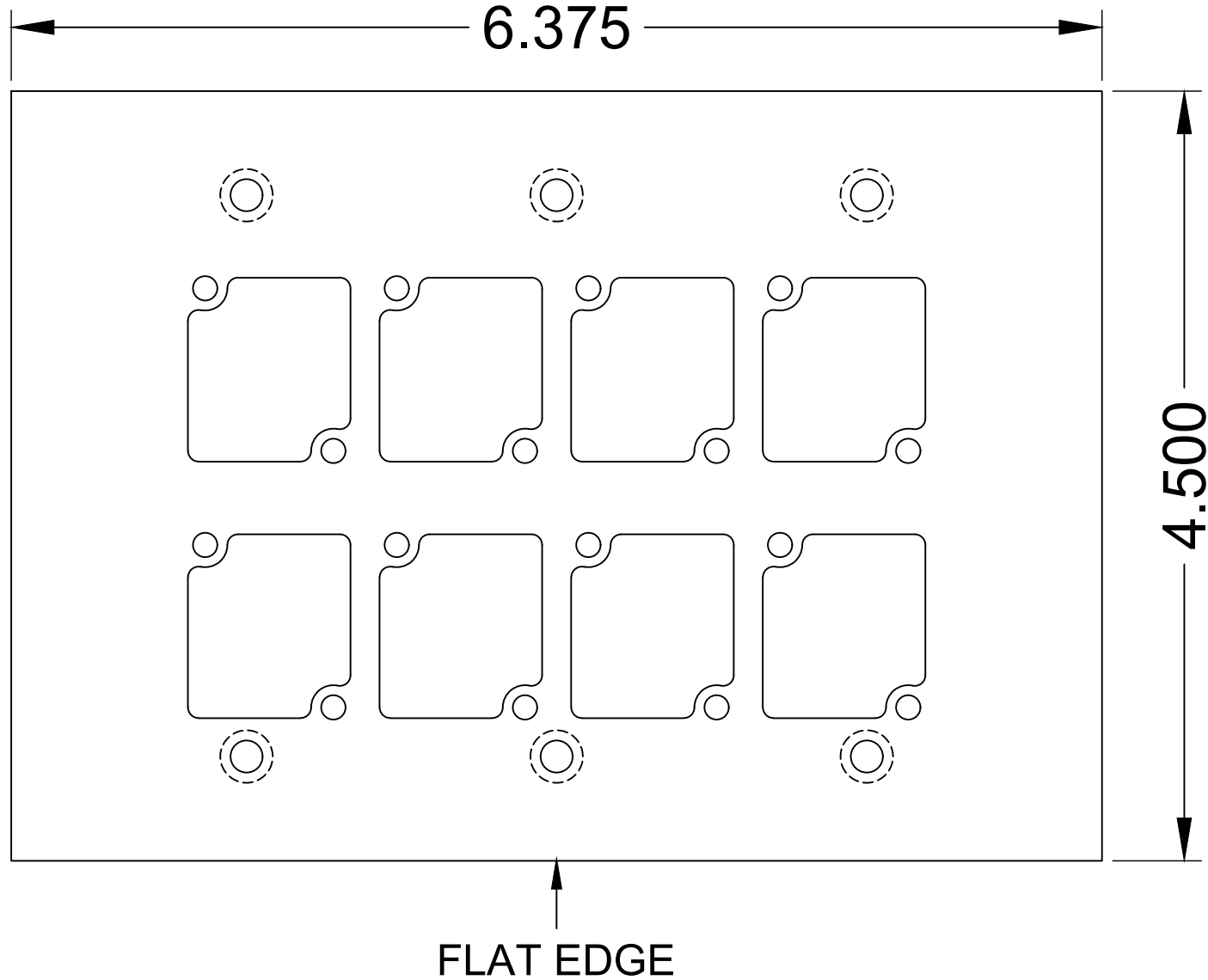
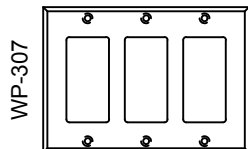
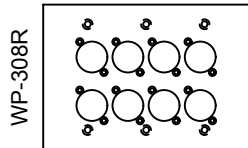
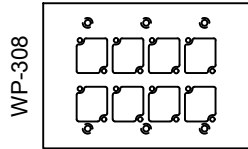
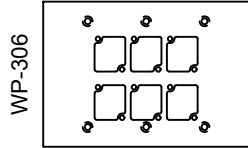
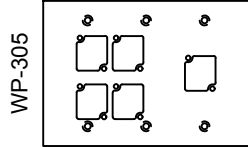
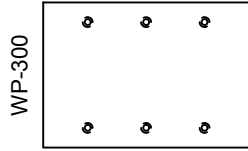

REVISED: 01/2021	MATERIAL:	FINISH:	DESCRIPTION:	REV 1
ALL DIMENSIONS ARE FOR REFERENCE ONLY. ALL DIMENSIONS ARE IN INCHES	1/16" 6061-T6 ALUMINUM	BLACK POWDER COAT, SEMI GLOSS	THREE-GANG WALL PANEL WITH (8) CONNECTRIX CUTOUTS.	SHEET 1 of 1

WP-300 SERIES PANELS

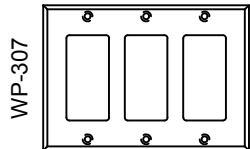
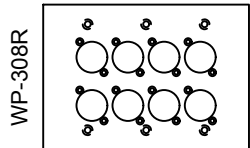
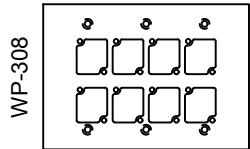
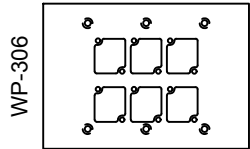
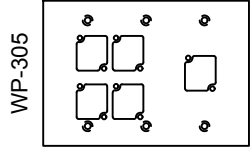
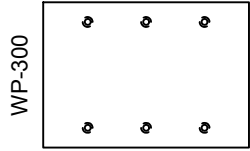

ROUND CUTOUT AND  
COUNTERSUNK MOUNTING HOLES  
FOR REAR LOADING CONNECTORS.

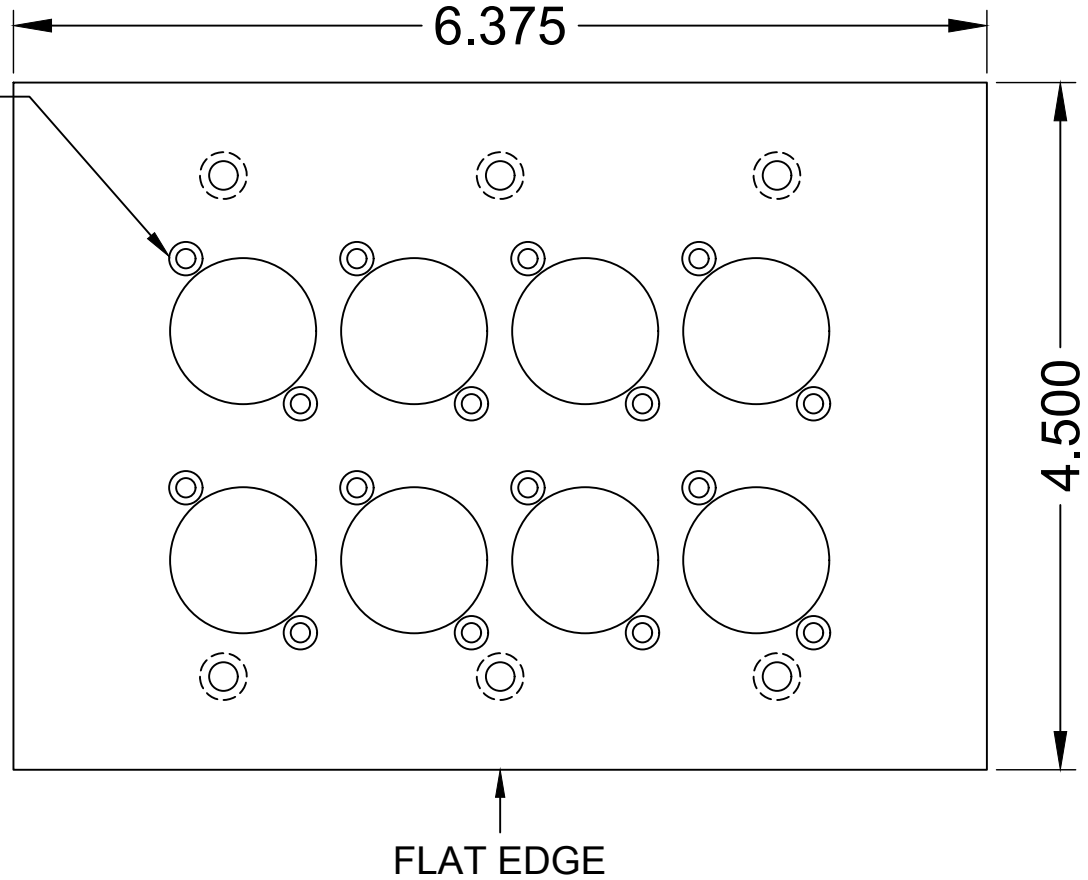

REVISED: 01/2021	MATERIAL:	FINISH:	DESCRIPTION:	REV 1
ALL DIMENSIONS ARE FOR REFERENCE ONLY. ALL DIMENSIONS ARE IN INCHES	1/16" 6061-T6 ALUMINUM	BLACK POWDER COAT, SEMI GLOSS	THREE-GANG PANEL WITH (8) ROUND CUTOUTS FOR REAR LOADING.	SHEET 1 of 1