

MODEL NO.	WP-200	SERIES	WP-200 SERIES	TYPE	2-GANG WALL PANEL	 PROUDLY MADE IN THE U.S.A.	 ACE BACKSTAGE CO Stage Pocket Systems <i>Connectivity</i> www.acebackstage.com
-----------	---------------	--------	----------------------	------	--------------------------	---	--

WP-200 SERIES PANELS

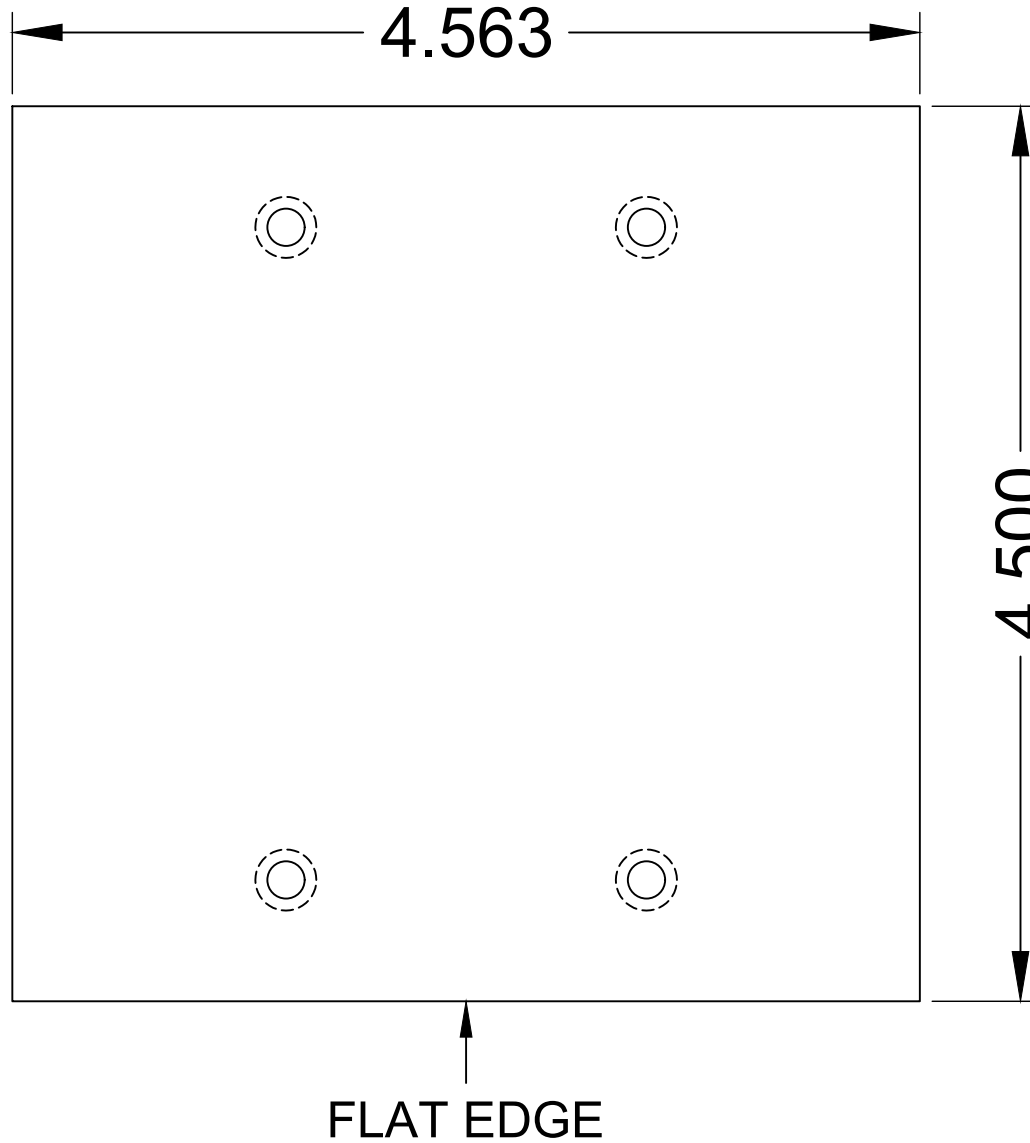
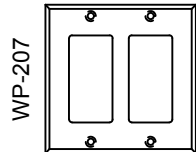
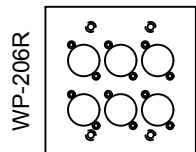
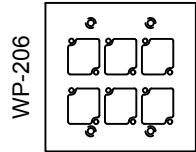
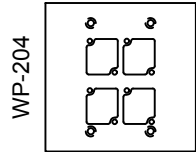
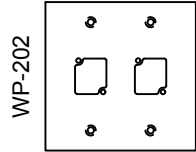
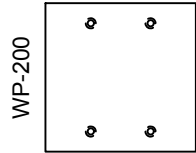

REVISED: 01/2021	MATERIAL:	FINISH:	DESCRIPTION:	REV 1
ALL DIMENSIONS ARE FOR REFERENCE ONLY. ALL DIMENSIONS ARE IN INCHES	1/16" 6061-T6 ALUMINUM	BLACK POWDER COAT, SEMI GLOSS	TWO-GANG WALL PANEL, BLANK.	SHEET 1 OF 1

WP-200 SERIES PANELS

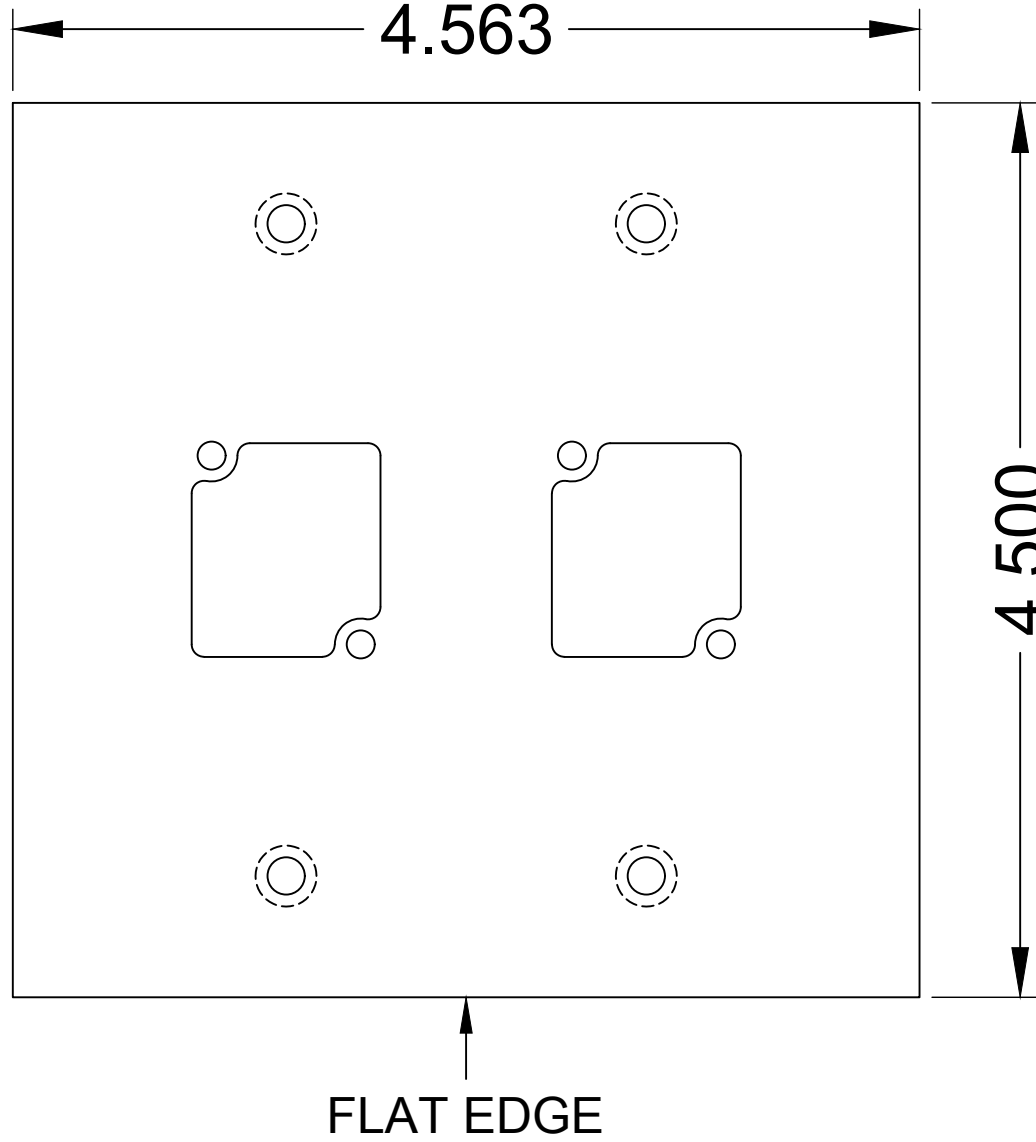
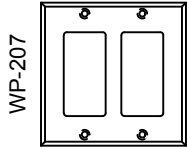
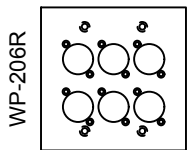
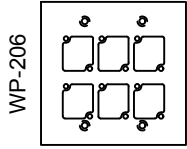
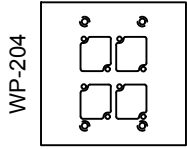
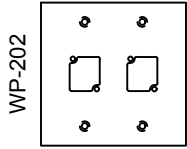
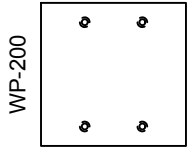

REVISED: 01/2021	MATERIAL:	FINISH:	DESCRIPTION:	REV 1
ALL DIMENSIONS ARE FOR REFERENCE ONLY. ALL DIMENSIONS ARE IN INCHES	1/16" 6061-T6 ALUMINUM	BLACK POWDER COAT, SEMI GLOSS	TWO-GANG WALL PANEL WITH (2) CONNECTRIX CUTOUTS.	SHEET 1 of 1

WP-200 SERIES PANELS

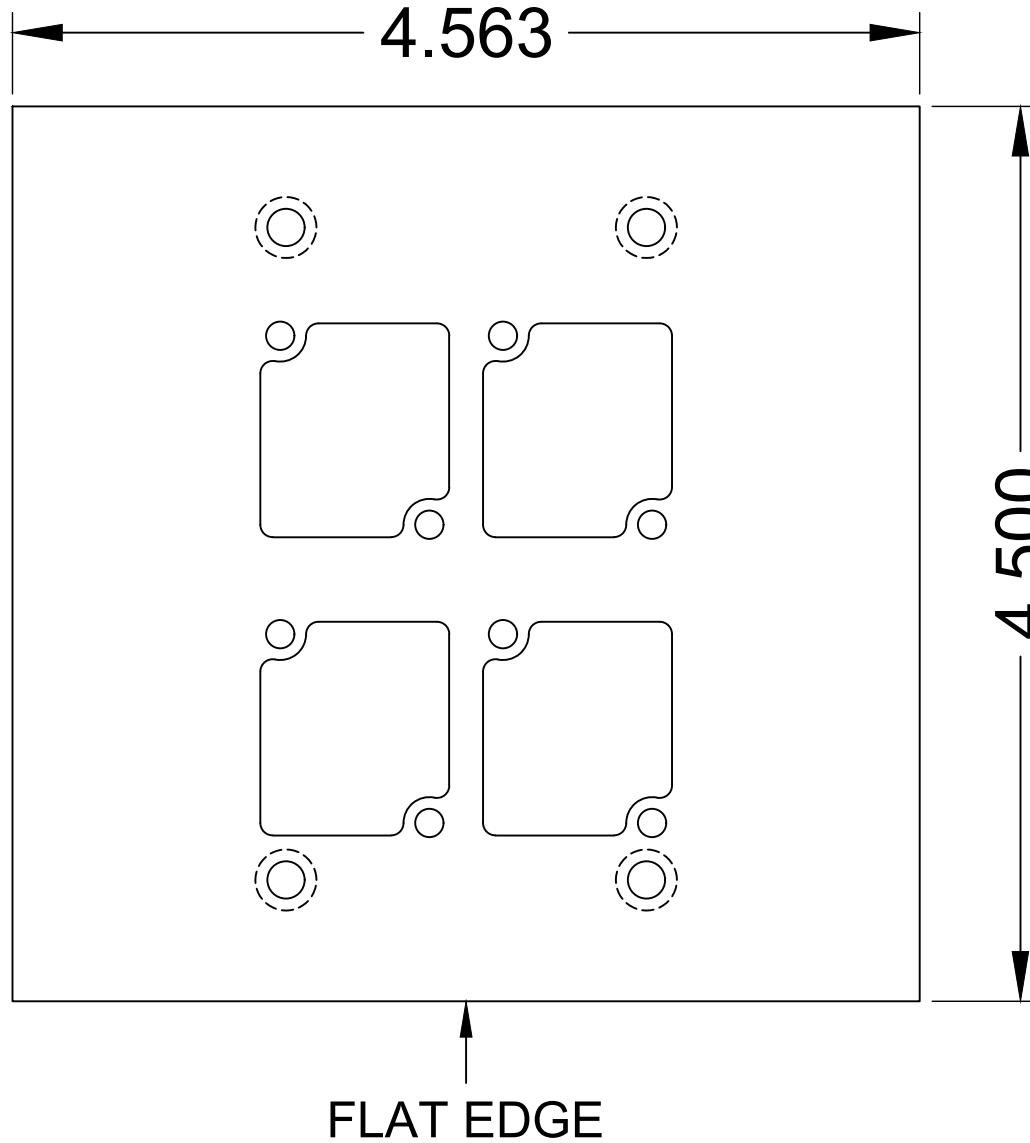
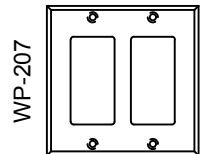
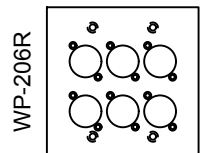
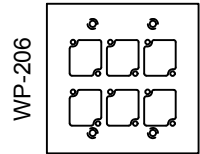
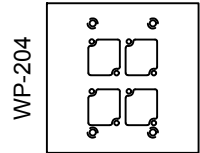
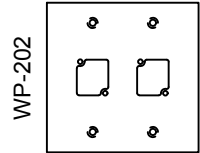
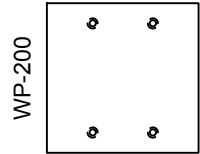

REVISED: 01/2021	MATERIAL:	FINISH:	DESCRIPTION:	REV 1
ALL DIMENSIONS ARE FOR REFERENCE ONLY. ALL DIMENSIONS ARE IN INCHES	1/16" 6061-T6 ALUMINUM	BLACK POWDER COAT, SEMI GLOSS	TWO-GANG PANEL WITH (4) CONNECTRIX CUTOUTS.	SHEET 1 of 1

WP-200 SERIES PANELS

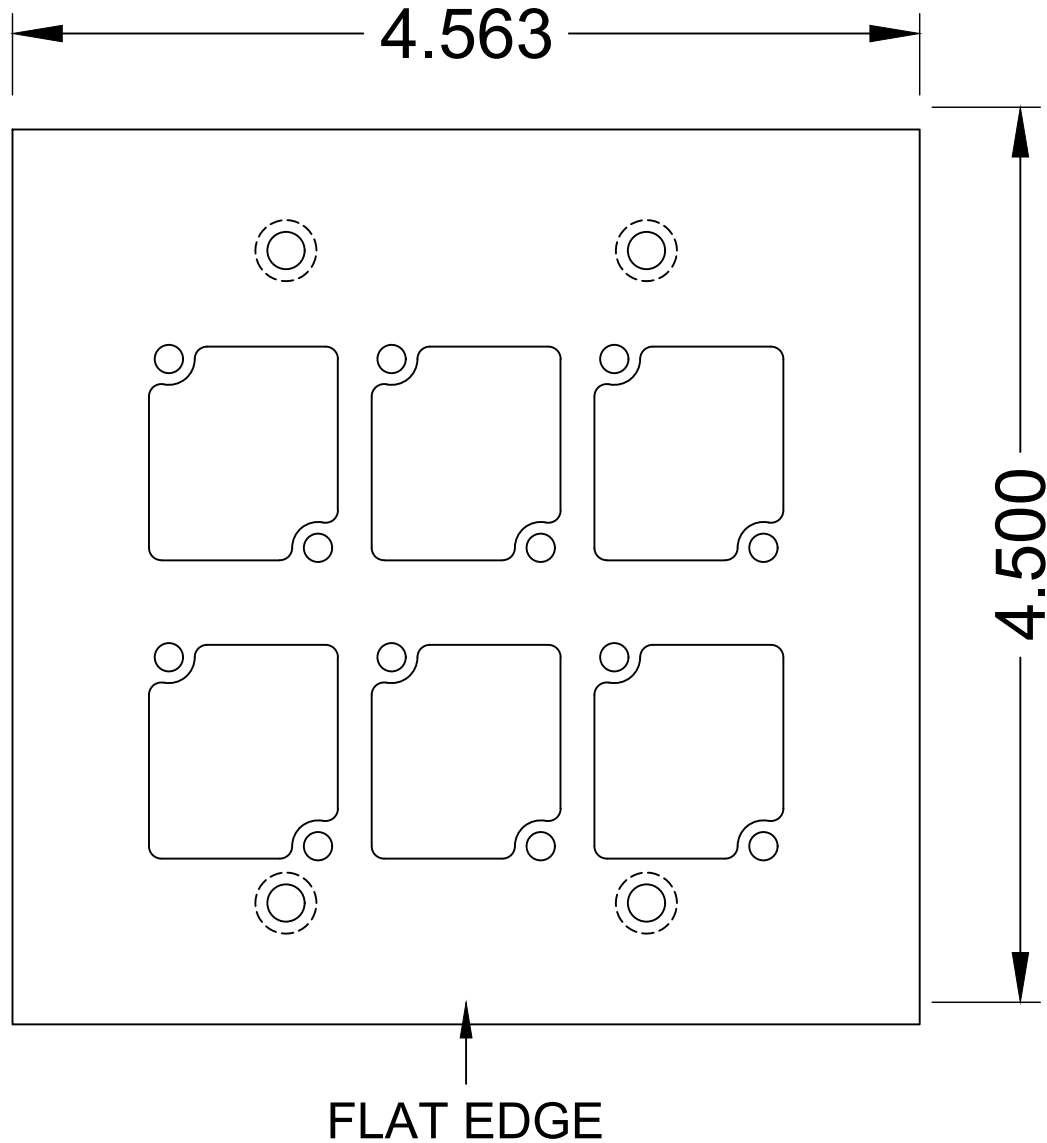
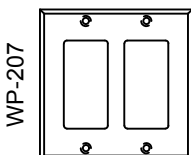
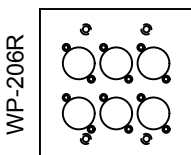
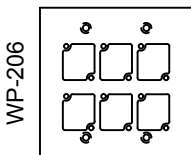
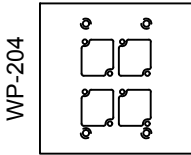
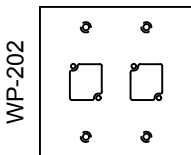
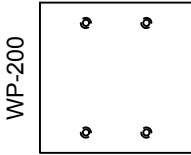

REVISED: 01/2021	MATERIAL:	FINISH:	DESCRIPTION:	REV 1
ALL DIMENSIONS ARE FOR REFERENCE ONLY. ALL DIMENSIONS ARE IN INCHES	1/16" 6061-T6 ALUMINUM	BLACK POWDER COAT, SEMI GLOSS	TWO-GANG PANEL WITH (6) CONNECTRIX CUTOUTS.	SHEET 1 of 1

WP-200 SERIES PANELS

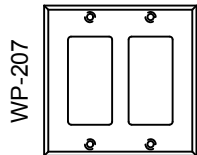
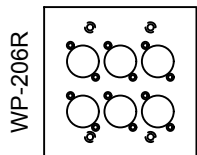
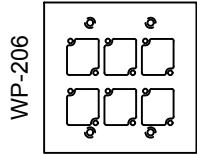
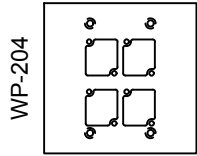
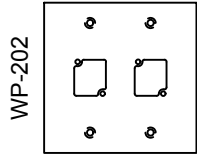
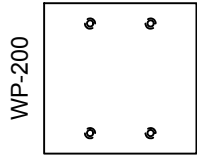

ROUND CUTOUT AND COUNTERSUNK MOUNTING HOLES FOR REAR LOADING CONNECTORS.

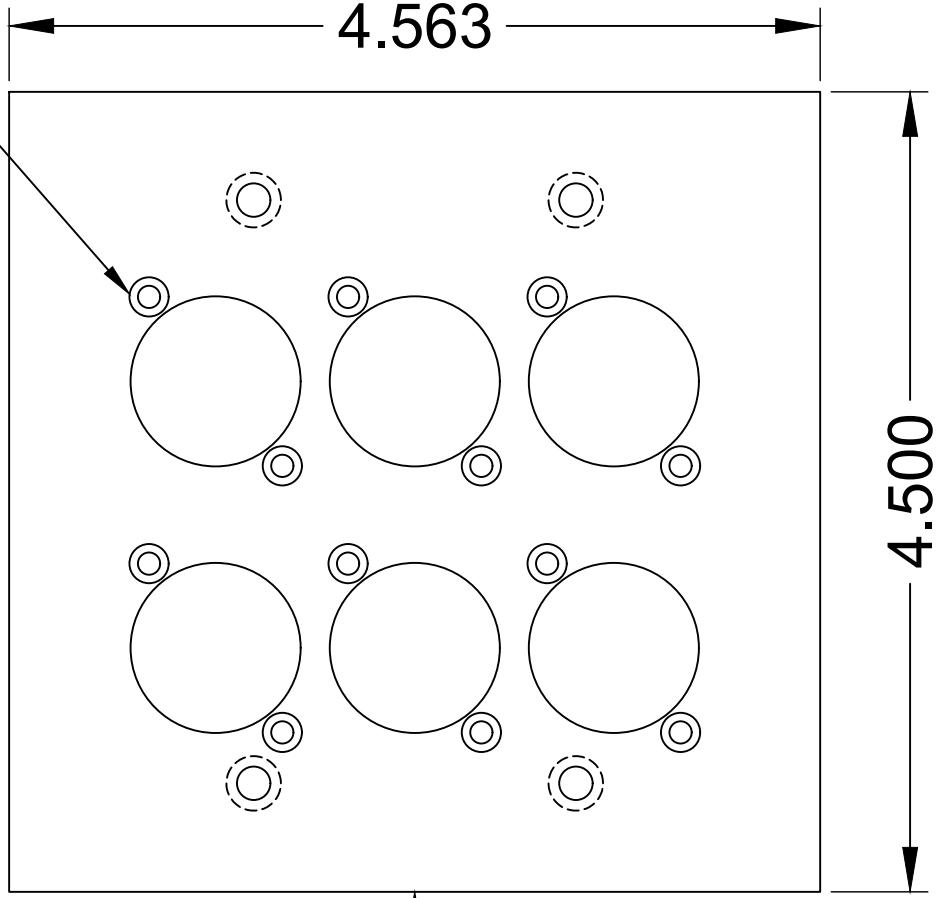

FLAT EDGE

REVISED: 01/2021	MATERIAL:	FINISH:	DESCRIPTION:	REV 1
ALL DIMENSIONS ARE FOR REFERENCE ONLY. ALL DIMENSIONS ARE IN INCHES	1/16" 6061-T6 ALUMINUM	BLACK POWDER COAT, SEMI GLOSS	TWO-GANG PANEL WITH (6) CUTOUTS	SHEET 1 of 1

WP-200 SERIES PANELS

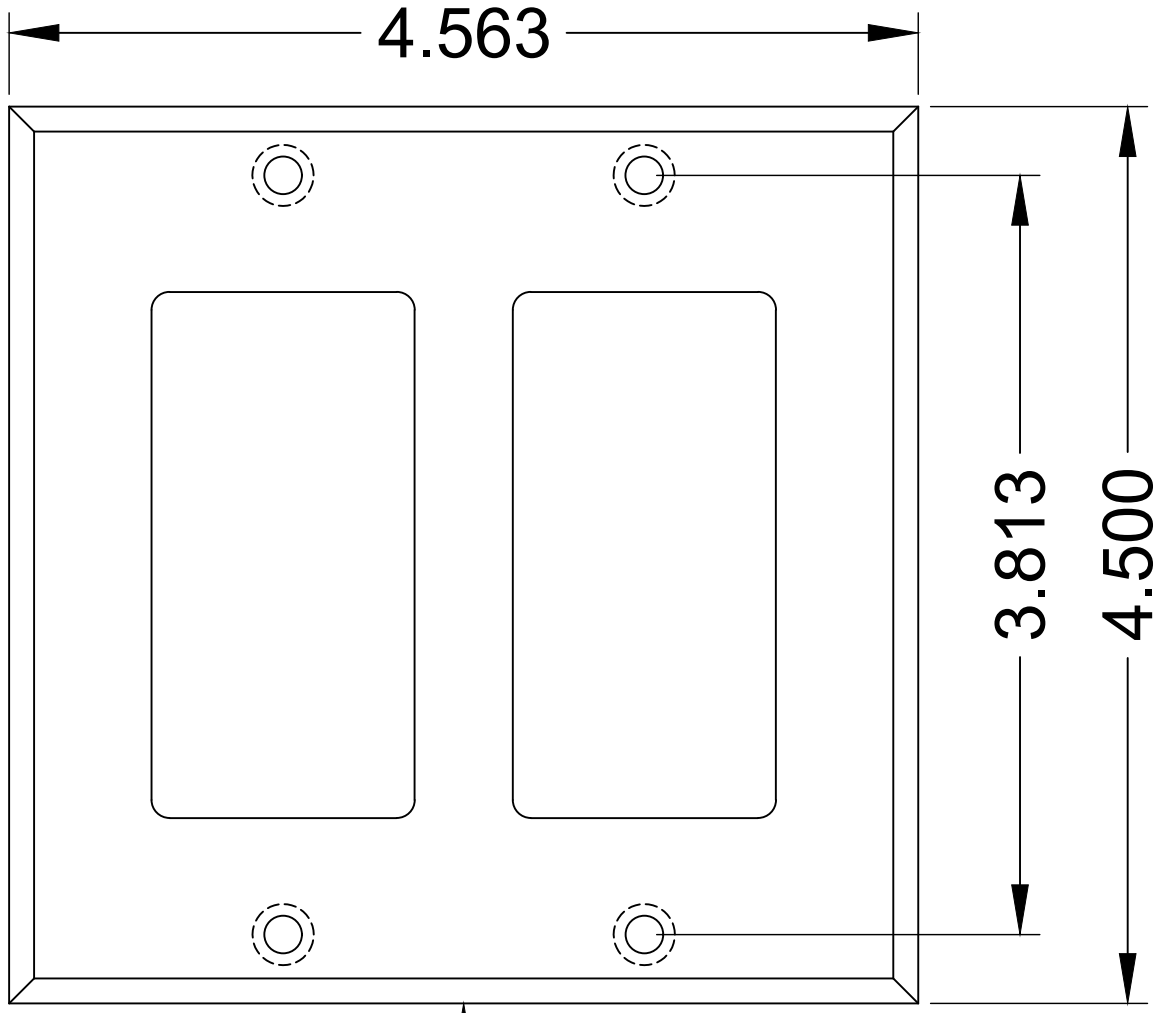
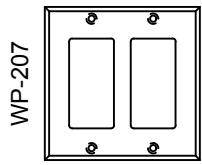
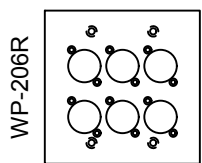
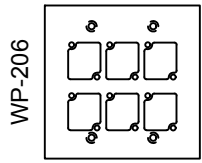
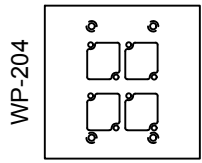
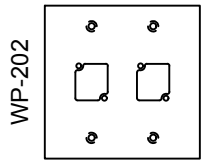
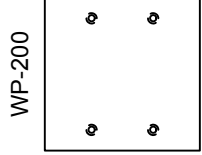

↑
BEVELED EDGE

REVISED: 01/2021	MATERIAL:	FINISH:	DESCRIPTION:	REV 1
ALL DIMENSIONS ARE FOR REFERENCE ONLY. ALL DIMENSIONS ARE IN INCHES	1/16" 6061-T6 ALUMINUM	BLACK POWDER COAT, SEMI GLOSS	TWO-GANG PANEL WITH (2) DECORA CUTOUTS	SHEET 1 OF 1