

WP-100 SERIES PANELS

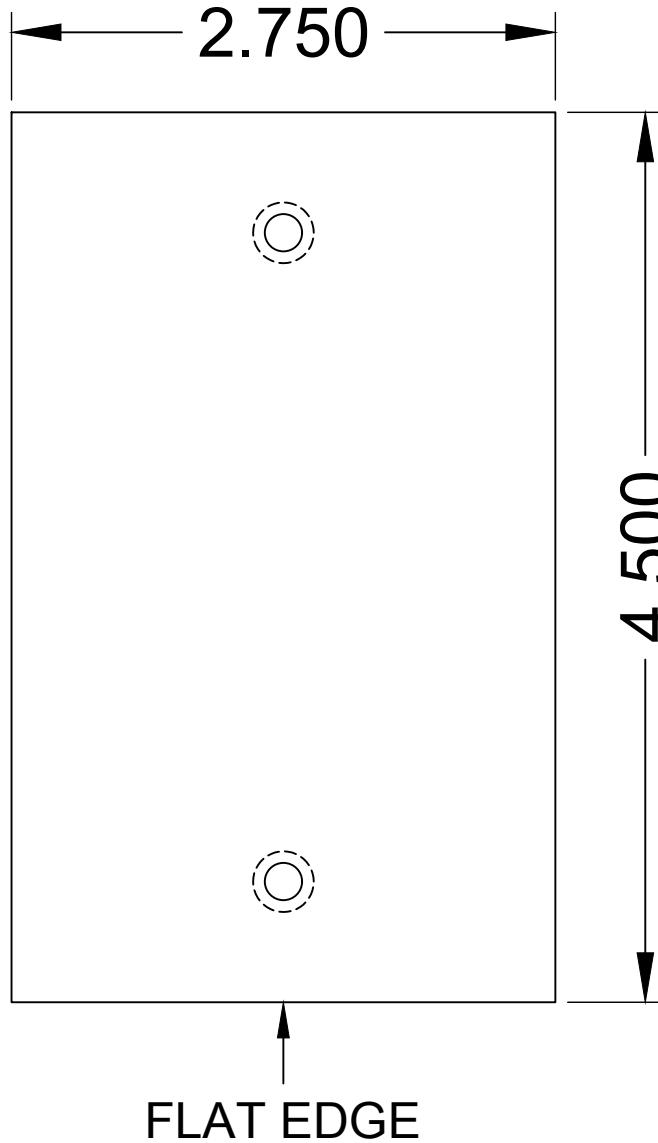

REVISED: 01/2021	MATERIAL:	FINISH:	DESCRIPTION:	REV 1
ALL DIMENSIONS ARE FOR REFERENCE ONLY. ALL DIMENSIONS ARE IN INCHES	1/16" 6061-T6 ALUMINUM	BLACK POWDER COAT, SEMI GLOSS	SINGLE GANG PANEL, BLANK.	SHEET 1 OF 1

WP-100 SERIES PANELS

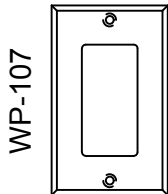
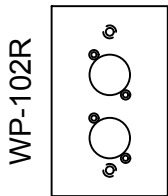
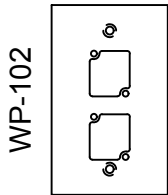
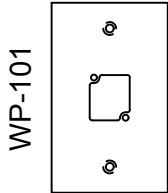
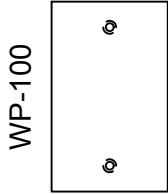
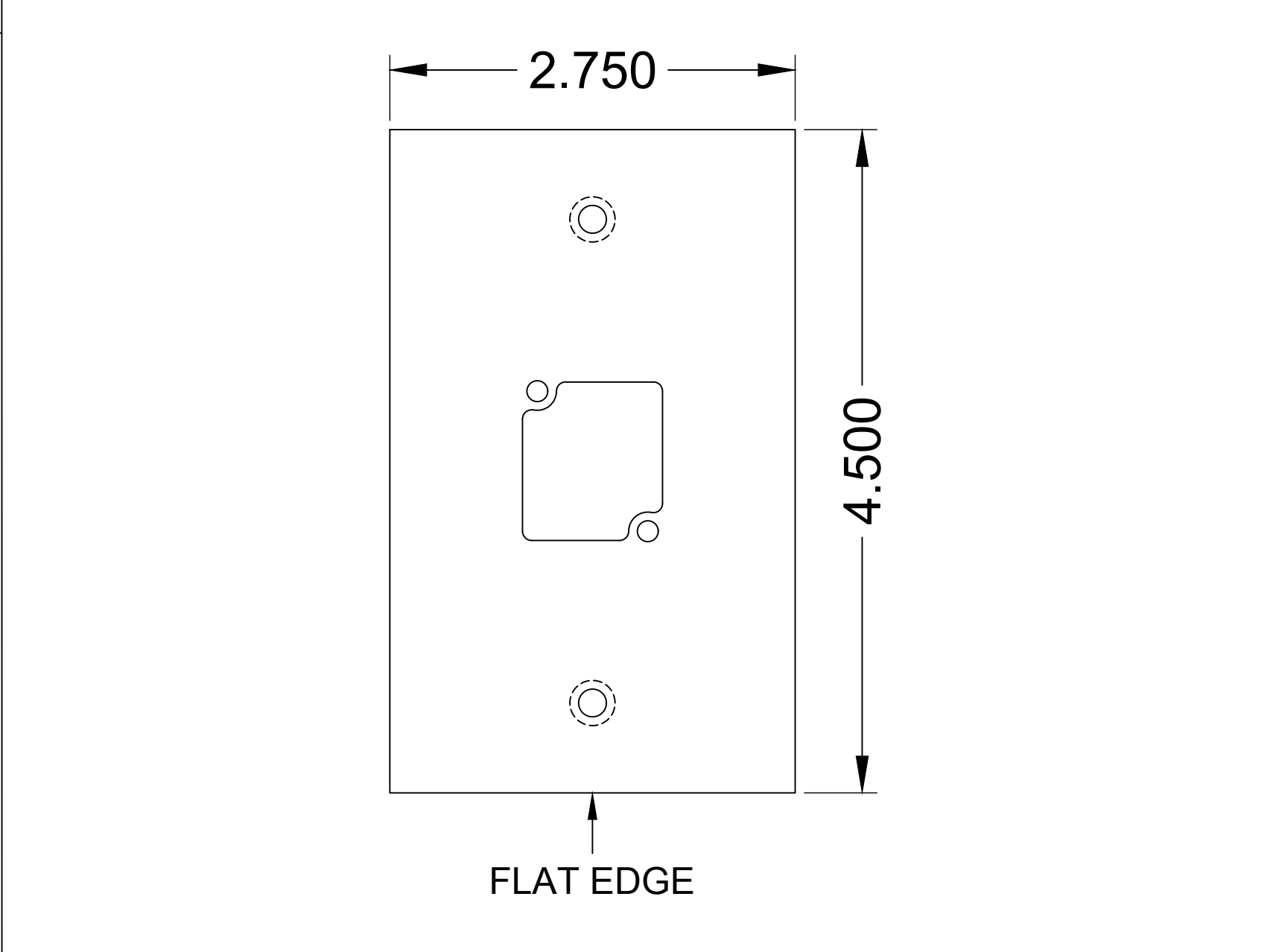
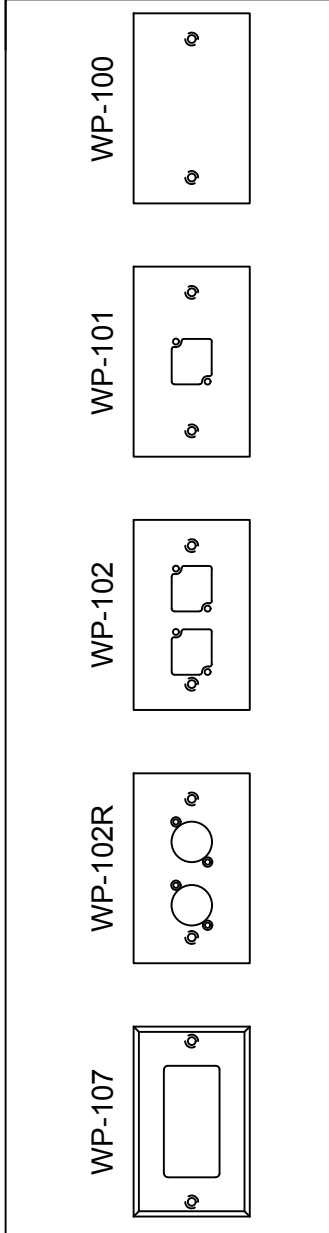

REVISED: 01/2021	MATERIAL:	FINISH:	DESCRIPTION:	REV 1
ALL DIMENSIONS ARE FOR REFERENCE ONLY. ALL DIMENSIONS ARE IN INCHES	1/16" 6061-T6 ALUMINUM	BLACK POWDER COAT, SEMI GLOSS	SINGLE GANG PANEL WITH (1) CONNECTRIX CUTOUT.	SHEET 1 of 1

WP-100 SERIES PANELS

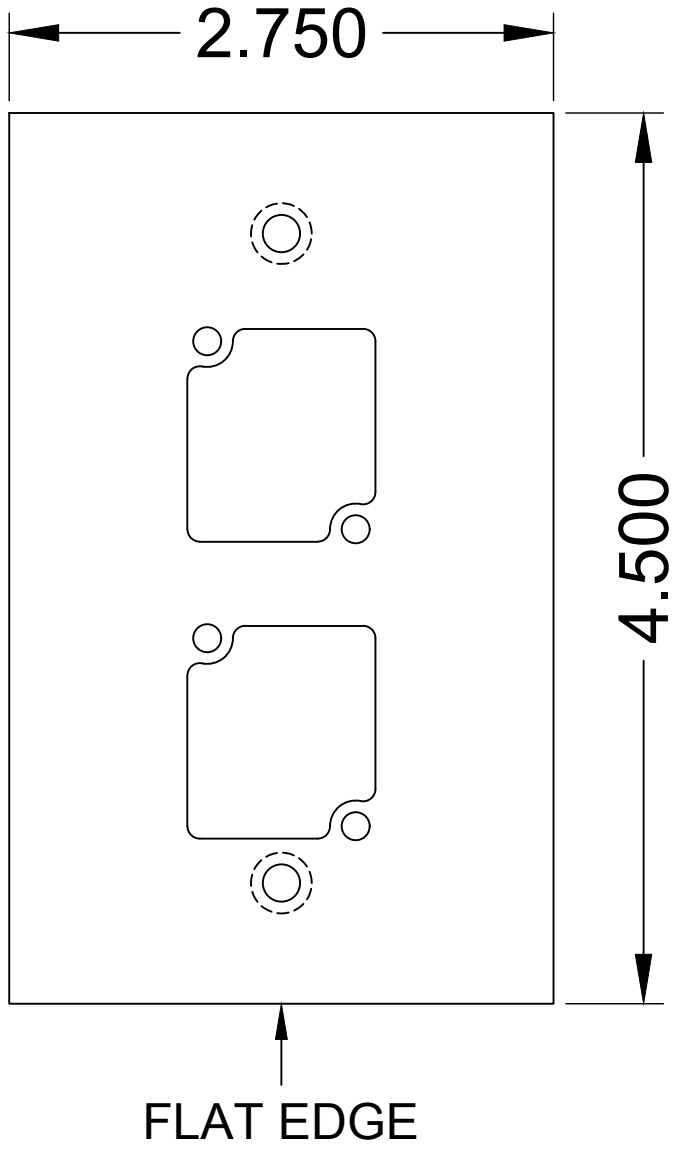
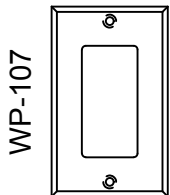
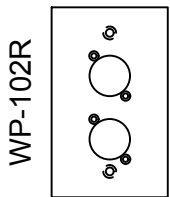
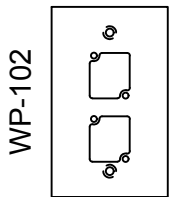
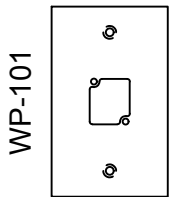
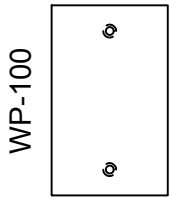

REVISED: 01/2021	MATERIAL:	FINISH:	DESCRIPTION:	REV 1
ALL DIMENSIONS ARE FOR REFERENCE ONLY. ALL DIMENSIONS ARE IN INCHES	1/16" 6061-T6 ALUMINUM	BLACK POWDER COAT, SEMI GLOSS	SINGLE GANG PANEL WITH (2) CONNECTRIX CUTOUTS.	SHEET 1 OF 1

MODEL NO.	WP-102R	SERIES	WP-100 SERIES	TYPE	1-GANG WALL PANEL	 PROUDLY MADE IN THE U.S.A.	 ACE BACKSTAGE CO Stage Pocket Systems Connectivity www.acebackstage.com
-----------	----------------	--------	----------------------	------	--------------------------	---	---

WP-100 SERIES PANELS

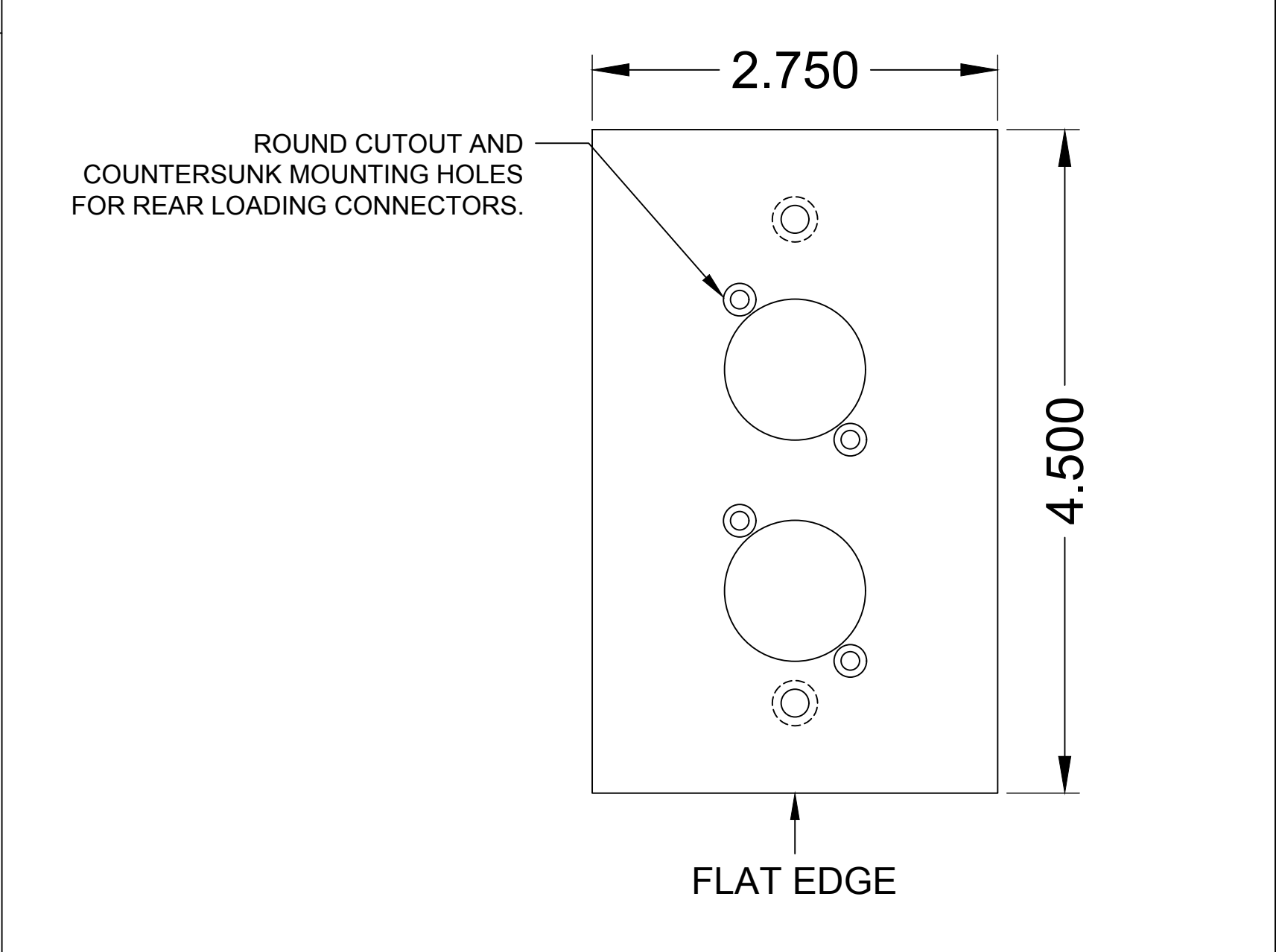
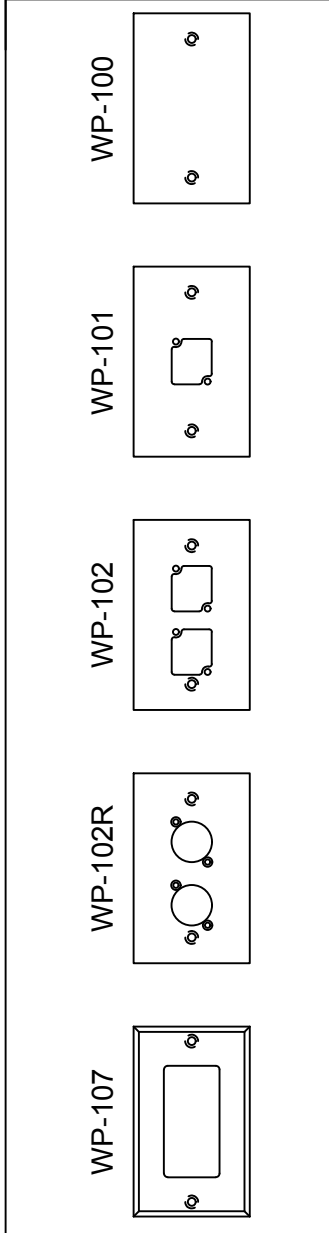

REVISED: 01/2021	MATERIAL:	FINISH:	DESCRIPTION:	REV 1
ALL DIMENSIONS ARE FOR REFERENCE ONLY. ALL DIMENSIONS ARE IN INCHES	1/16" 6061-T6 ALUMINUM	BLACK POWDER COAT, SEMI GLOSS	SINGLE GANG PANEL WITH (2) ROUND CUTOUTS FOR REAR LOADING.	SHEET 1 OF 1

MODEL NO.	WP-107	SERIES	WP-100 SERIES	TYPE	1-GANG WALL PANEL	 PROUDLY MADE IN THE U.S.A.	 ACE BACKSTAGE CO Stage Pocket Systems <i>Connectivity</i> www.acebackstage.com
-----------	---------------	--------	----------------------	------	--------------------------	--	--

WP-100 SERIES PANELS

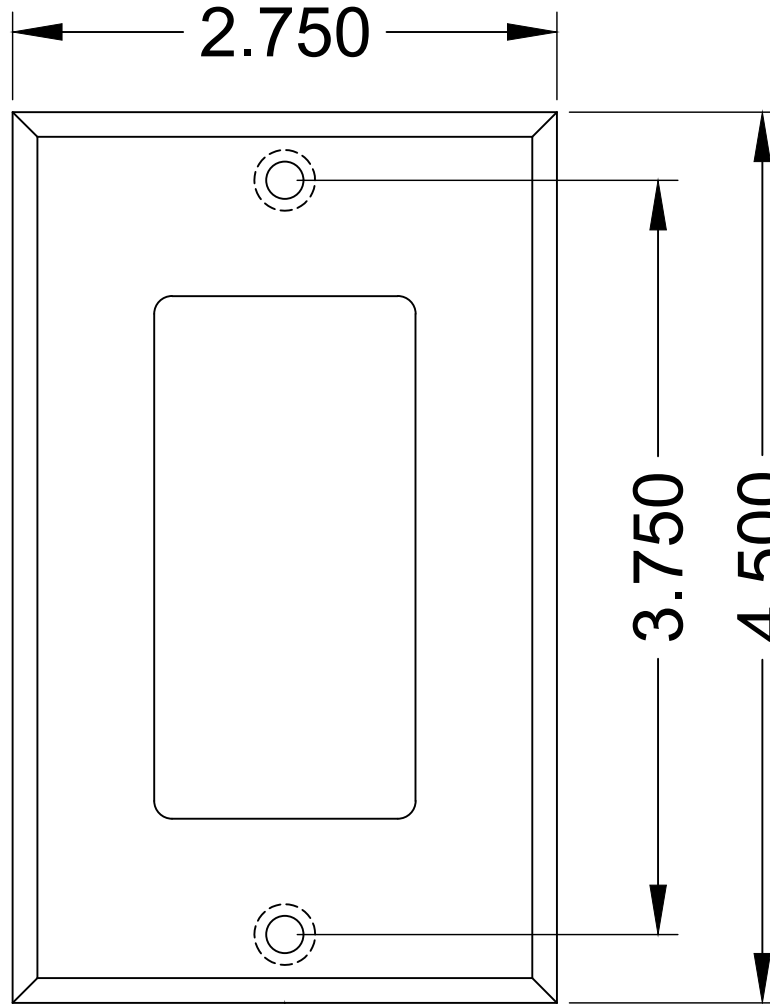
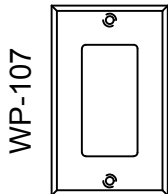
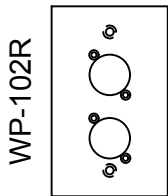
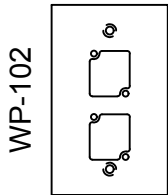
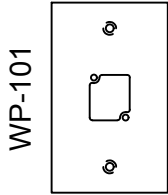
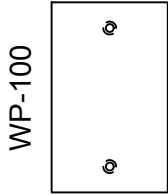

BEVELED EDGE

REVISED: 01/2021	MATERIAL:	FINISH:	DESCRIPTION:	REV 1
ALL DIMENSIONS ARE FOR REFERENCE ONLY. ALL DIMENSIONS ARE IN INCHES	1/16" 6061-T6 ALUMINUM	BLACK POWDER COAT, SEMI GLOSS	SINGLE GANG PANEL WITH (1) DECORA CUTOUT	SHEET 1 of 1