

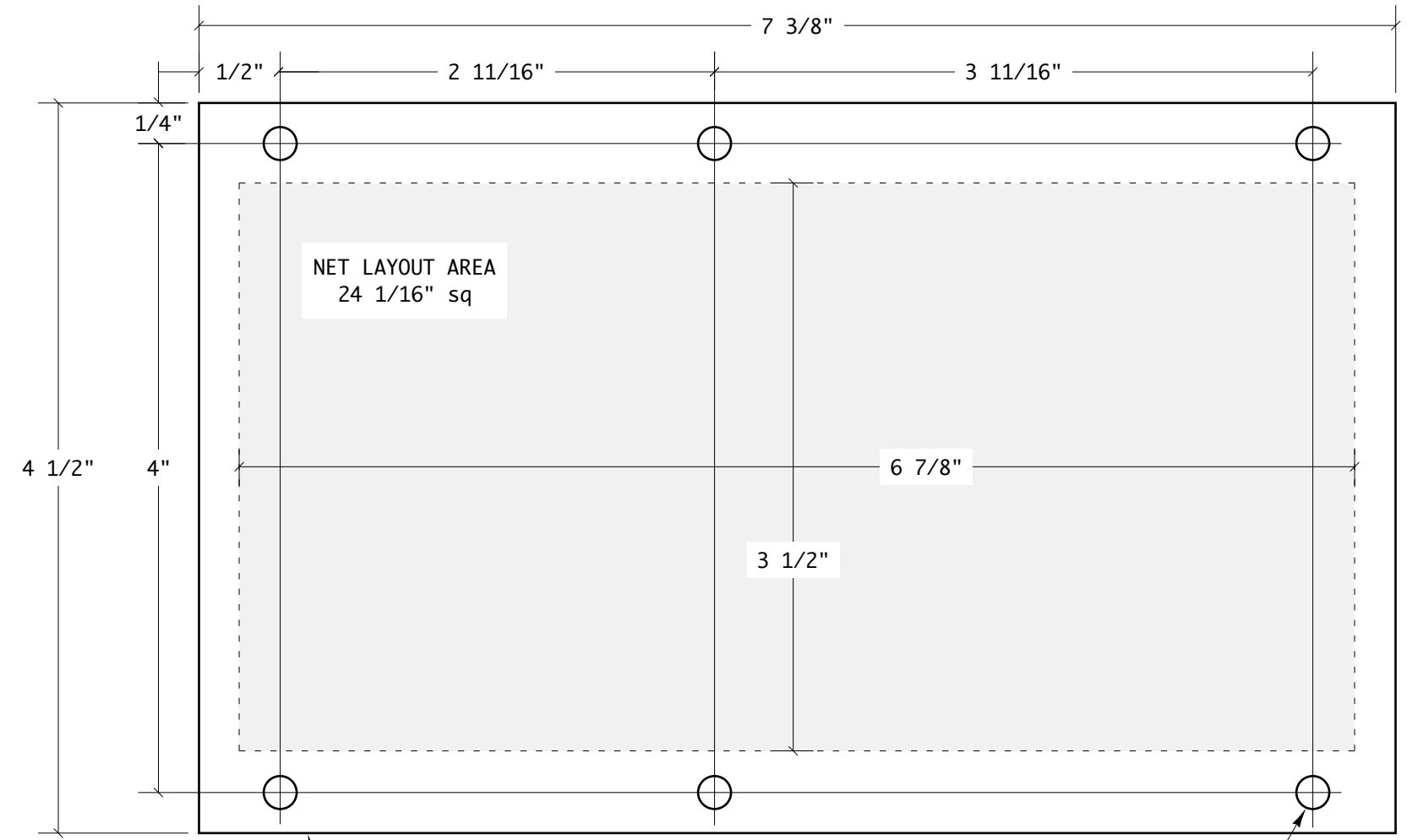



"CONNECTRIX" SYSTEM

REVISIONS				
ZONE	REV	DESCRIPTION	DATE	APPROVED



13/64" Diameter  
(6) Places

Made from high strength aluminum alloy (6061-T6), 1/16" thick. Finished with oven-cured semi-gloss black powder coat.

<small>ALL DIMENSIONS ARE FOR REFERENCE ONLY. UNLESS OTHERWISE SPECIFIED ALL DIMENSIONS ARE IN INCHES.</small>	APPROVALS		DATE	 <b>ACE BACKSTAGE CO., INC. - STAGE POCKET SYSTEMS</b> 24846 Avenue Rockefeller • Suite 200 • Valencia, CA 91355 Tel: 661-295-5760 • Fax: 661-295-1122 • Web: www.acebackstage.com
	DRAWN		04/22/08	
	ENGINEER			
	CHECKED			
TREATMENT	APPROVED			TITLE
FINISH	ISSUED			<b>#PNL-120 "CONNECTRIX" PANEL, BLANK</b>
SIMILAR TO	MARKING SYMBOL	SCALE: 1:1	DWG NO. PNL-120.pdf	REV
		"CONNECTRIX" POCKET PANEL	SHEET 1 OF 1	



"CONNECTRIX" SYSTEM

REVISIONS				
ZONE	REV	DESCRIPTION	DATE	APPROVED

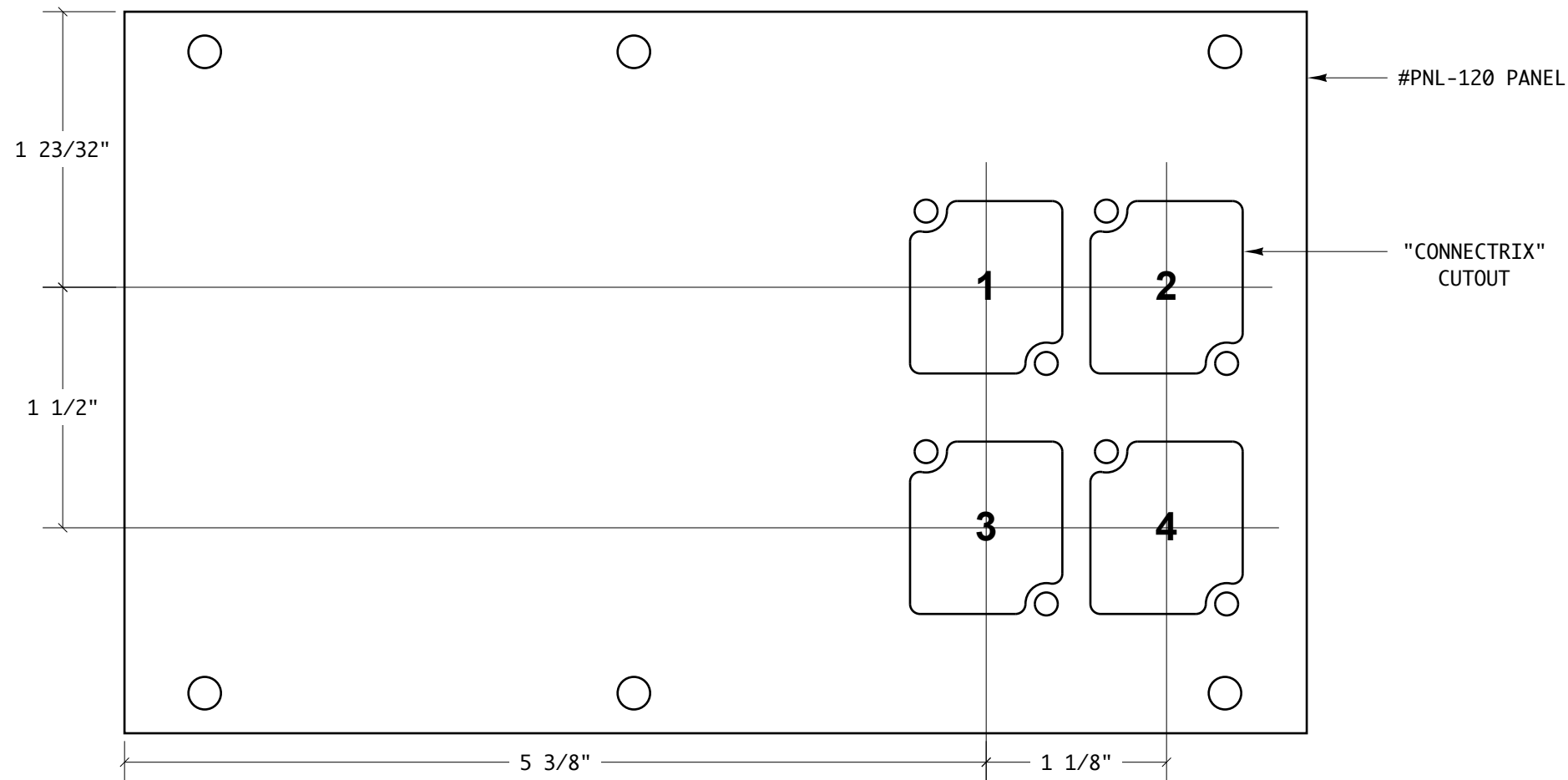



<small>ALL DIMENSIONS ARE FOR REFERENCE ONLY. UNLESS OTHERWISE SPECIFIED ALL DIMENSIONS ARE IN INCHES.</small>	APPROVALS		DATE	 <b>ACE BACKSTAGE CO., INC. - STAGE POCKET SYSTEMS</b> 24846 Avenue Rockefeller • Suite 200 • Valencia, CA 91355 Tel: 661-295-5760 • Fax: 661-295-1122 • Web: www.acebackstage.com
	DRAWN		04/22/08	
	ENGINEER			
	TREATMENT	CHECKED		
FINISH	APPROVED			TITLE <b>#PNL-124 "CONNECTRIX" PANEL,          (4) "CONNECTRIX" MOUNTS</b>
SIMILAR TO	MARKING SYMBOL	ISSUED		SIZE <b>B</b> DWG NO. <b>PNL-124.pdf</b> REV
			SCALE: 1:1	<b>"CONNECTRIX" POCKET PANEL</b> SHEET <b>1</b> OF <b>1</b>

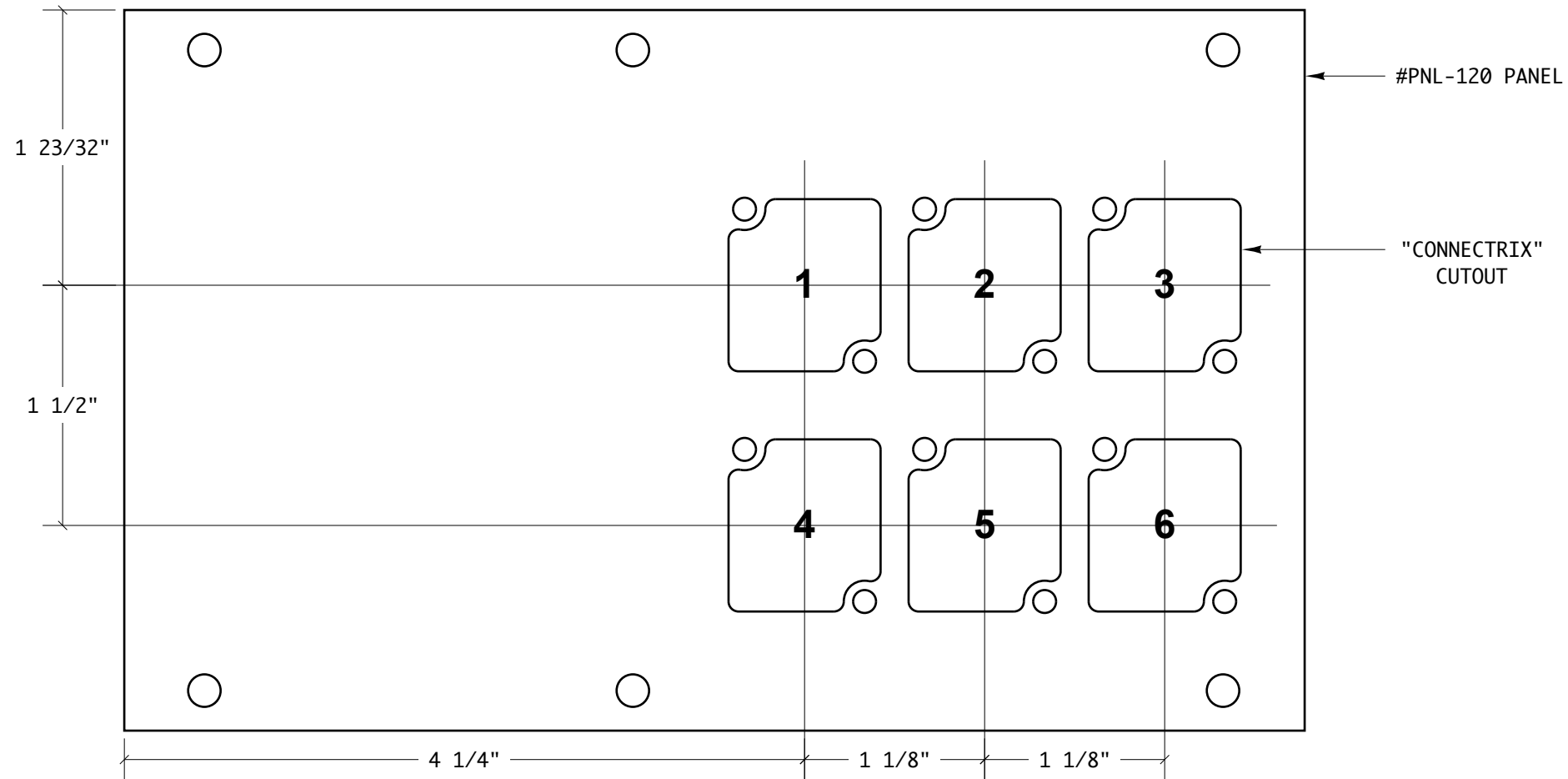

"CONNECTRIX" SYSTEM

REVISIONS				
ZONE	REV	DESCRIPTION	DATE	APPROVED





<small>ALL DIMENSIONS ARE FOR REFERENCE ONLY. UNLESS OTHERWISE SPECIFIED ALL DIMENSIONS ARE IN INCHES.</small>	APPROVALS	DATE	 <b>ACE BACKSTAGE CO., INC. - STAGE POCKET SYSTEMS</b> 24846 Avenue Rockefeller • Suite 200 • Valencia, CA 91355 Tel: 661-295-5760 • Fax: 661-295-1122 • Web: www.acebackstage.com
	DRAWN	04/22/08	
TREATMENT	ENGINEER		TITLE
FINISH	CHECKED		<b>#PNL-126 "CONNECTRIX" PANEL, (6) "CONNECTRIX" MOUNTS</b>
SIMILAR TO	MARKING SYMBOL	ISSUED	SIZE <b>B</b> DWG NO. <b>PNL-126.pdf</b> REV
SCALE: 1:1		"CONNECTRIX" POCKET PANEL	SHEET 1 OF 1

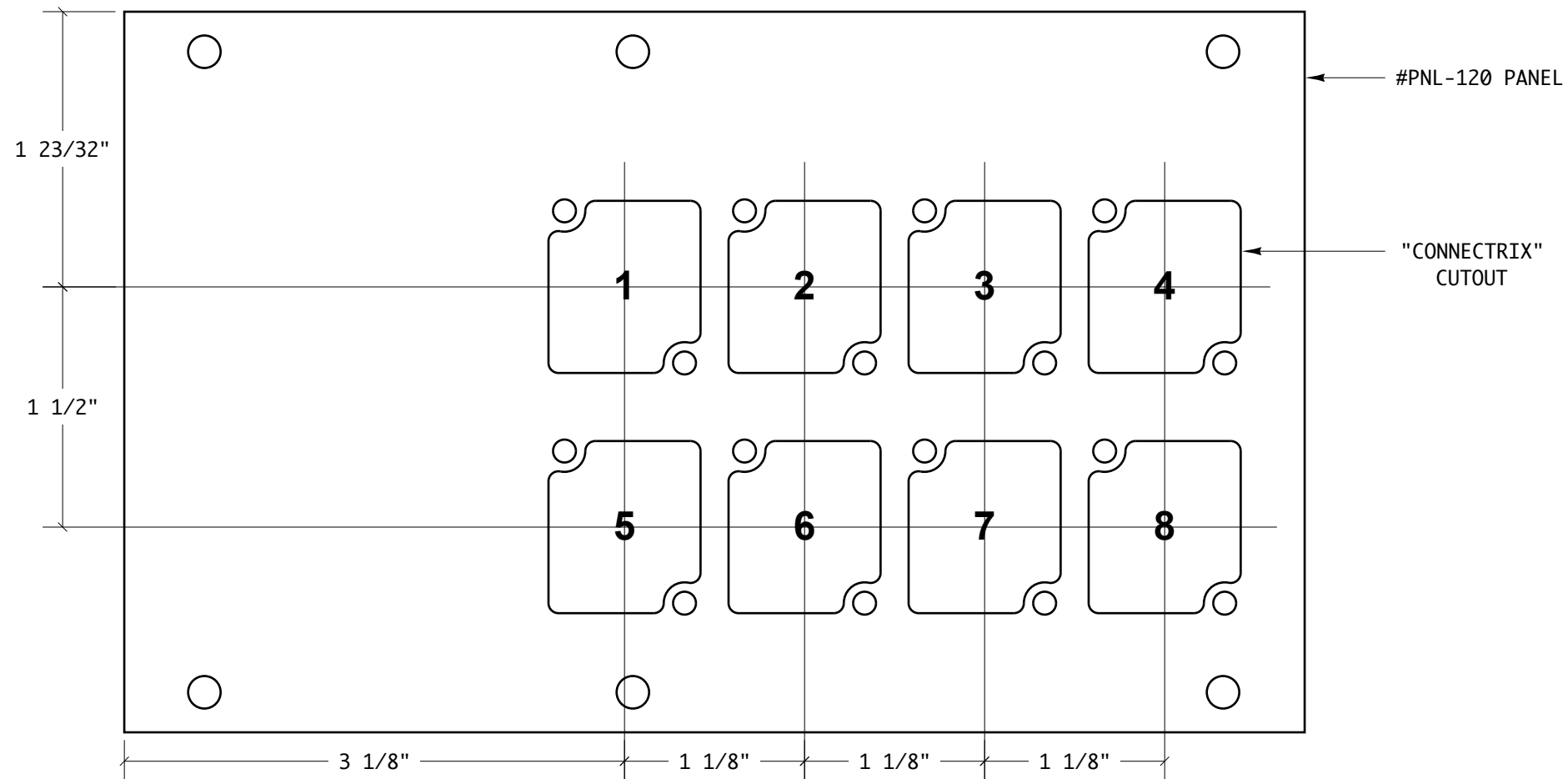

"CONNECTRIX" SYSTEM

REVISIONS				
ZONE	REV	DESCRIPTION	DATE	APPROVED





<small>ALL DIMENSIONS ARE FOR REFERENCE ONLY. UNLESS OTHERWISE SPECIFIED ALL DIMENSIONS ARE IN INCHES.</small>	APPROVALS		DATE	 <b>ACE BACKSTAGE CO., INC. - STAGE POCKET SYSTEMS</b> 24846 Avenue Rockefeller • Suite 200 • Valencia, CA 91355 Tel: 661-295-5760 • Fax: 661-295-1122 • Web: www.acebackstage.com
	DRAWN		04/22/08	
	ENGINEER			
	TREATMENT	CHECKED		
FINISH	APPROVED			TITLE <b>#PNL-128 "CONNECTRIX" PANEL,          (8) "CONNECTRIX" MOUNTS</b>
SIMILAR TO	MARKING SYMBOL	ISSUED		SIZE <b>B</b> DWG NO. <b>PNL-128.pdf</b> REV
			SCALE: 1:1	<b>"CONNECTRIX" POCKET PANEL</b> SHEET 1 OF 1

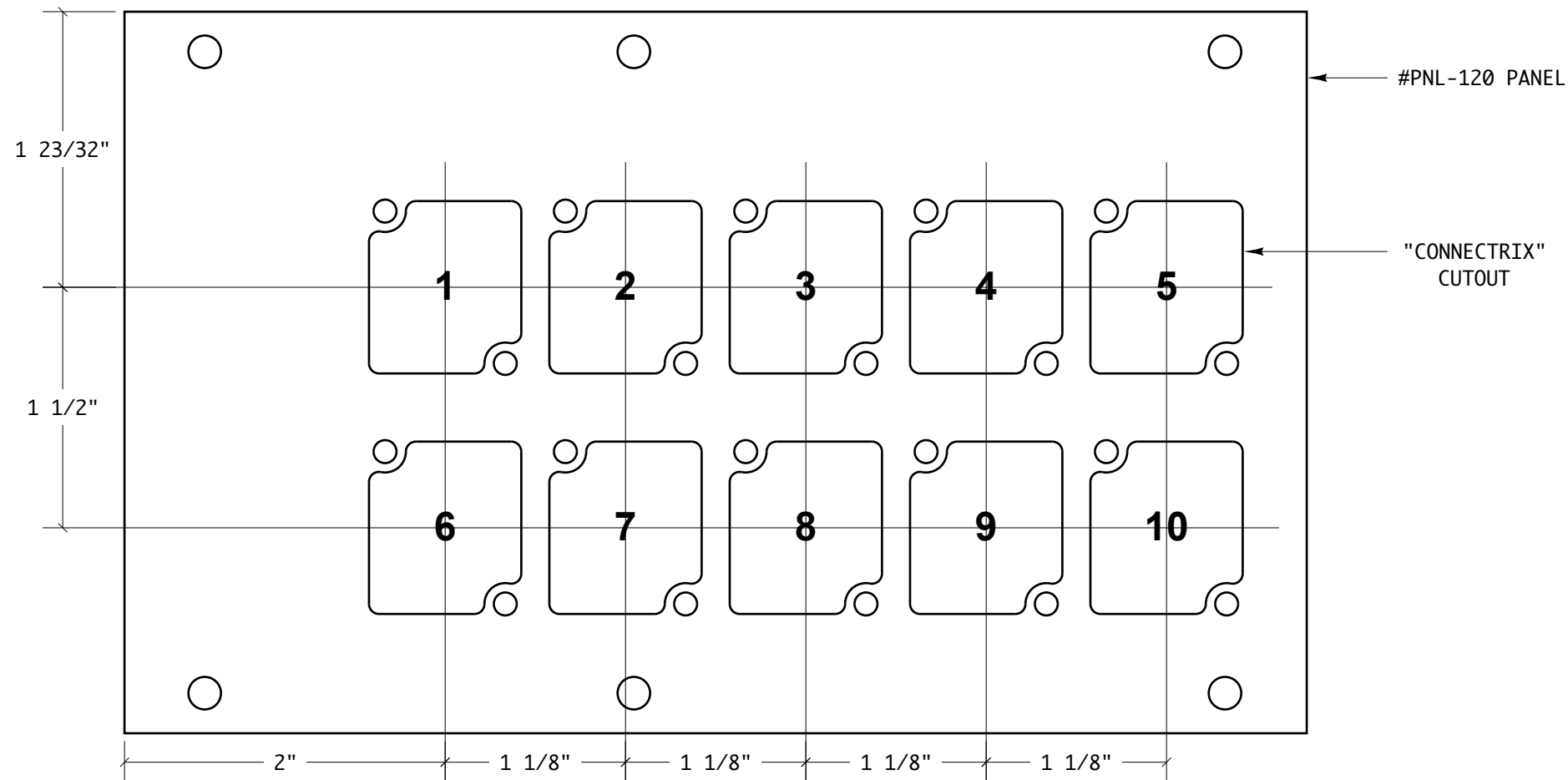

"CONNECTRIX" SYSTEM

REVISIONS				
ZONE	REV	DESCRIPTION	DATE	APPROVED





<small>ALL DIMENSIONS ARE FOR REFERENCE ONLY. UNLESS OTHERWISE SPECIFIED ALL DIMENSIONS ARE IN INCHES.</small>	APPROVALS		DATE	 <b>ACE BACKSTAGE CO., INC. - STAGE POCKET SYSTEMS</b> 24846 Avenue Rockefeller • Suite 200 • Valencia, CA 91355 Tel: 661-295-5760 • Fax: 661-295-1122 • Web: www.acebackstage.com
	DRAWN		04/22/08	
	ENGINEER			
	CHECKED			
TREATMENT	APPROVED			TITLE <b>#PNL-1210 "CONNECTRIX" PANEL,          (10) "CONNECTRIX" MOUNTS</b>
FINISH	ISSUED			SIZE <b>B</b> DWG NO. <b>PNL-1210.pdf</b> REV
SIMILAR TO	MARKING SYMBOL	SCALE: 1:1		"CONNECTRIX" POCKET PANEL SHEET 1 OF 1

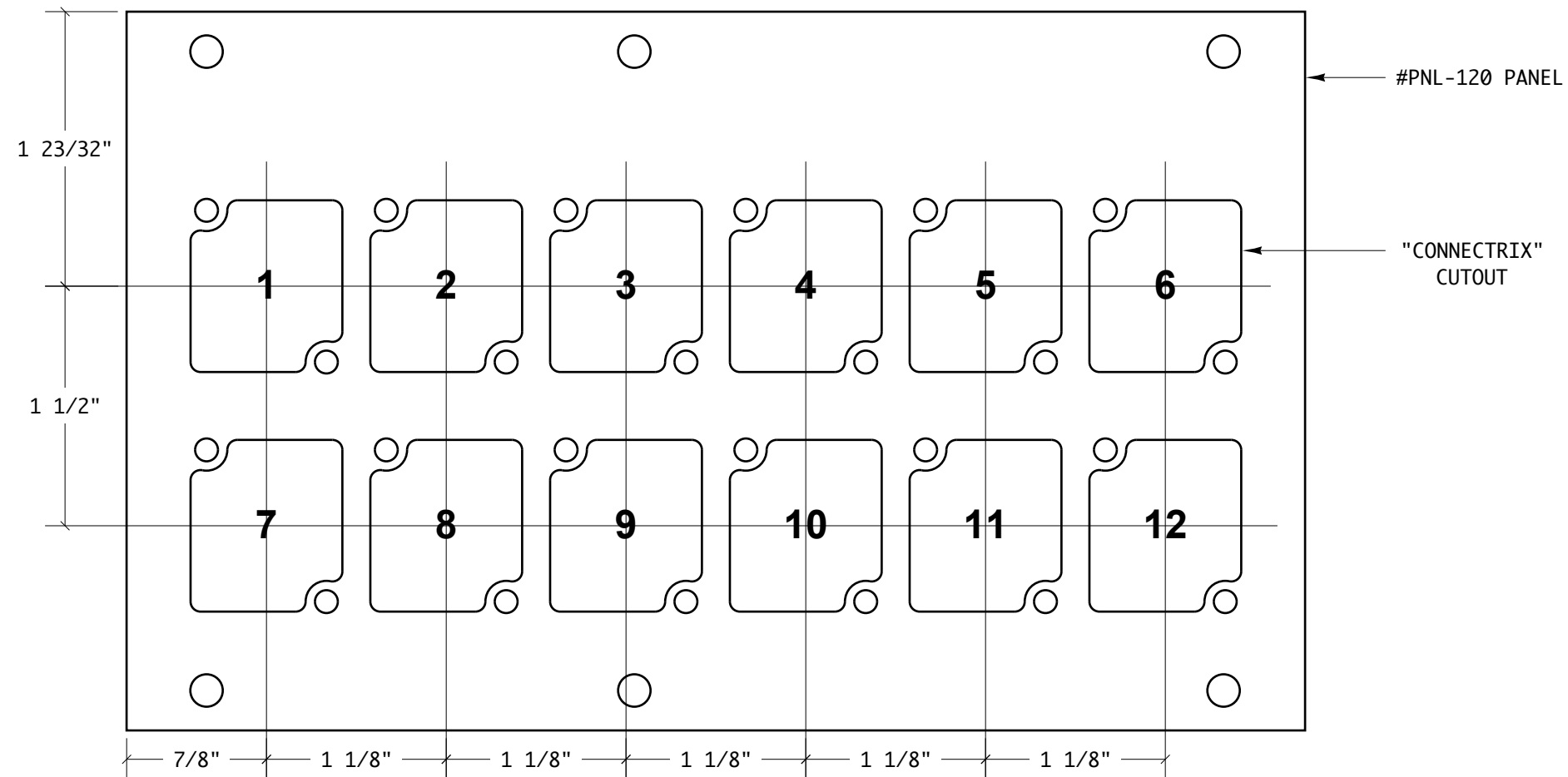

"CONNECTRIX" SYSTEM

REVISIONS				
ZONE	REV	DESCRIPTION	DATE	APPROVED



<small>ALL DIMENSIONS ARE FOR REFERENCE ONLY. UNLESS OTHERWISE SPECIFIED ALL DIMENSIONS ARE IN INCHES.</small>	APPROVALS		DATE	 <b>ACE BACKSTAGE CO., INC. - STAGE POCKET SYSTEMS</b> 24846 Avenue Rockefeller • Suite 200 • Valencia, CA 91355 Tel: 661-295-5760 • Fax: 661-295-1122 • Web: www.acebackstage.com
	DRAWN		04/22/08	
	ENGINEER			
TREATMENT	CHECKED			TITLE <b>#PNL-1212 "CONNECTRIX" PANEL,          (12) "CONNECTRIX" MOUNTS</b>
FINISH	APPROVED			SIZE <b>B</b> DWG NO. <b>PNL-1212.pdf</b> REV
SIMILAR TO	MARKING SYMBOL	ISSUED		SCALE: <b>1:1</b> "CONNECTRIX" POCKET PANEL SHEET <b>1</b> OF <b>1</b>